

AGRICUT 180 ROTARY MOWER

FOR USE ON MACHINE WGC 9918002

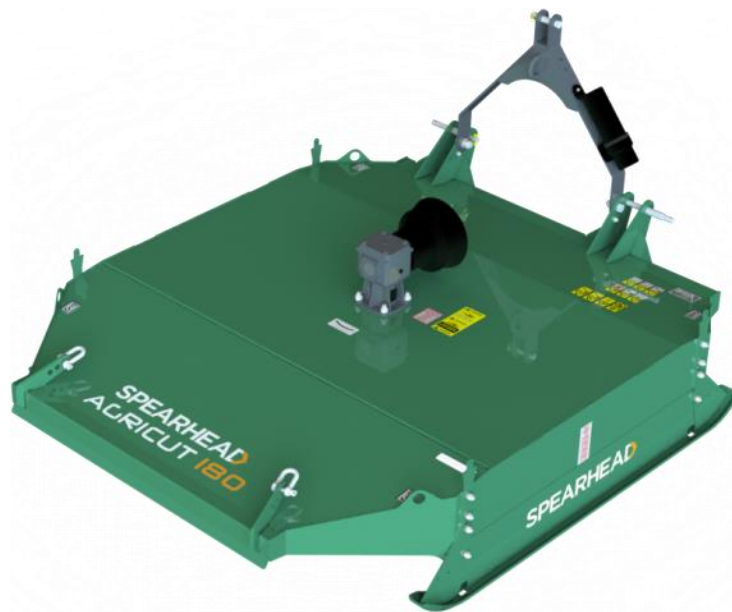

Edition 1.0 – September 2018
Part No. 8999129

Model type: Type modèle : <i>Entwerfen Sie Typ:</i>		Agricut 180
Model number: Nombre modèle : <i>Entwerfen Sie Zahl:</i>		9918002
Serial numbers: Numéros de série : Seriennummern:	Machine: Machine: <i>Maschine:</i>	S _____
	Cutting implement: Instrument de coupe: <i>Schneidenwerkzeug</i>	S _____
	Other: Autre: <i>Anderer:</i>	
Name of owner: Le nom de propriétaire : <i>Name des Eigentümers:</i>		
Date of delivery / installation: La date de livraison/l'installation : <i>Datum der Lieferung / Installation:</i>		

IMPORTANT

At the point of transfer of ownership record the above information. Note the serial number of your machine and always quote it in any communication with us or your dealer. (The serial number plate is located on the machine mainframe.) This is particularly important when ordering spares. Remember to include all numbers and letters.

The information given throughout this manual is correct at the time of publication. However, in the course of constant development of Spearhead machines, changes in specification are inevitable. Should you find the information given in this book to be at variance with the machine in your possession, you are advised to contact the Spearhead Service department where up-to-date information will be provided.

The manual can contain standard and optional features and is not to be used as a machine specification.

The machine has been tested and is considered safe if carefully used. Ensure your operator is properly trained in its use and maintenance.

IMPORTANT

Au point de transfert de possession enregistrez les informations ci-dessus mentionnées. Noter le numéro de série de votre machine et mentionnez les dans toute communication avec nos services ou votre revendeur. (La plaque de numéro de série est localisée sur le central de machine). Ceci est important pour la commande de pièces détachées. Pensez à noter tous les numéros et toutes les lettres.

Les informations données dans ce manuel sont correctes cependant, du fait de développement constant des machines Spearhead. Changements dans les caractéristiques sont inévitables. Si vous trouvez que les informations données ne correspondent pas à votre machine veuillez contacter le service des réparations ou des informations plus récentes vous seront données.

Ce manuel peut montrer des caractéristiques optionnelles et ne peut pas être considéré comme spécification de la machine. Cette machine a été testée, et elle est considérée comme fiable à condition d'une bonne utilisation. Assurez-vous que votre opérateur est qualifié en ce qui concerne l'utilisation de la machine ainsi que son entretien.

WICHTIG

Am Punkt der Übertragung des Eigentumsrecht zeichnet die oberen Informationen auf. Merken Sie die Seriennummer von Ihrer Maschine ein und geben sie diese immer an, wenn sie sich an uns oder ihren Händler wenden. (Die Seriennummerplatte ist auf der Maschinenzentraleinheit befunden). Das ist besonders bei ersatzteilbestellungen wichtig. Vergessen sie nicht, alle zahlen und buchstaben zu notieren.

Die angaben in diesem handbuch sind bei veröffentlichung korrekt. Aufgrund der konstanten weiterentwicklung von Spearhead maschinen sind jedochänderungen in der spezifikation unvermeidlich. Wenn die information in diesem handbuch nicht mit ihrer maschine übereinstimmen, nehmen sie bitte kontakt mit der Spearhead kundendienstabteilung auf, die ihnen gerne die aktuellen information zukommen lässt.

Das handbuch kann sowohl beschreibungen für die standard ausführung als auch für zubehör enthalten und ist nicht als maschinenspezifikation zu verwendet. Die maschine ist getestet und bei sachgemäßem betrieb als sicher befunden worden. Sorgen sie dafür, dass ihr bedienpersonal in anwendung und wartung richtig geschult wird.

EC DECLARATION OF CONFORMITY

Conforming to EU Directive 2006/42/EC & ISO 9001:2015

We,

Of SPEARHEAD MACHINERY LIMITED, Station Road, Salford Priors, Evesham, Worcestershire, WR11 8SW, UK.

Declare that under our sole responsibility the product (type);

Rotary Mower	Product Code
Agricut 180	AG18

Which is a rotary mowing, tractor linkage mounted, vegetation control machine;

Serial No(s). & Date:.....

Manufactured by: ALAMO MANUFACTURING SERVICES (UK) Limited, Station Road, Salford Priors, Evesham, Worcestershire, WR11 8SW, UK.

In terms of its design, method of construction and execution thereof, the item of machinery described above complies with the basic health and safety regulations of the respective EU Directives. The Machinery Directive is supported by the following harmonized standards:

- Directive 2006/2/EC
- Directive 2004/108/EC
- BS EN ISO 12100:2010

And other national standards associated with its design and construction as listed in the technical file.

SPEARHEAD MACHINERY LIMITED operates an ISO 9001:2015 quality management system.
The system is accredited by;

BSI, Beech House, Linford Wood, Milton Keynes, UK, MK14 6ES
BSI identification number: UKAS 003
Spearhead Machinery certificate number: FM 649800



Signed

On behalf of SPEARHEAD MACHINERY LIMITED Responsible person

Status: Managing Director

Date: 05/09/2016

Agricut 180: 1.80m Cut, 540 PTO, In-line Topper

This manual covers the Agricut 180 series of topper mowers which are 1.80m cut, rear mounted, 540 PTO, in-line machine, perfect for grasslands and paddocks. These efficient, small farm machines consist of a main deck, A-frame linkage system and individual swinging blades.

The Agricut series is powered through a 540 PTO drive from the rear of a suitable tractor.

Standard features include 1.80m cutting width, shaft driven, variable cutting height, three-point linkage a-frame mounting with reversible CAT1/2 lower link pins, shear bolt PTO protection and head/deck float.

The Spearhead Agricut 180 series is primarily designed for the topping of grass pasture land after grazing, or for thistle and weed control on agricultural land. The Spearhead Agricut 180 machines are not designed for grass mowing or for set-aside cutting along with brush/woodland clearance.

In the interest of safety and for the protection of your mower you must never use this machine to perform tasks it was not designed to do.

IMPORTANT

This operator's manual should be regarded as part of the machine. Suppliers of both new and second hand machines are advised to retain documentary evidence that this manual was provided with the machine.

This machine is designed solely for vegetation control and must not be used for any other purpose. Use in any other way is considered as contrary to the intended use. Compliance with, and strict adherence to, the conditions of operation, service, and repair, as specified by the manufacturer, also constitute essential elements of the intended use.

This machine should be operated, serviced, and repaired only by persons who are familiar with its particular characteristics and who are acquainted with the relevant safety procedures.

Accident prevention regulations, all other generally recognised regulations on safety and occupational medicine, and all road traffic regulations must be observed at all times.

Any arbitrary modifications carried out to this machine may relieve the manufacturer of liability for any resulting damage or injury.

It is potentially hazardous to fit or use any parts other than genuine **Spearhead** parts.

The company disclaims all liability for the consequences of such use which, in addition, voids the machine warranty.

Contents List

1	Machine Description	7
	1.1 Intended usage	7
	1.2 General arrangement	8
	1.3 Machine rotation convention	9
	1.4 Machine general specification	9
2	Safety	1
	2.1 Safe operation	1
	2.2 Safety warnings	1
	2.3 Stopping in an emergency	6
	2.4 Dangers due to overhead power lines	6
	2.4.1 Risk assessment	6
	2.4.2 Emergency Action for Accidents Involving Electricity	6
	2.5 Noise	7
	2.6 Personal Protective Equipment	8
	2.7 Guards	8
	2.8 Tractor stability	8
	2.9 Working on inclined ground	9
	2.10 Working on embankments	9
3	Safety Decals	1
4	Lubricants	1
	4.1 Filling the Gearbox	1
5	Installation	1
	5.1 Unpacking the machine	1
	5.1.1 Lifting the machine	1
	5.2 Tractor preparation	2
	5.2.1 Tractor requirements	2
	5.3 Attaching the machine	3
	5.3.2 Setting the cutting height	4
	5.4 PTO driveshaft installation	4
	5.4.1 Shortening the PTO length	5
	5.4.2 PTO Maintenance	5
	5.5 Installation checks	5
	5.5.1 Initial run-up	5
	5.5.2 Checking Head float	6
6	General operation	1
	6.1 Operator training	1
	6.2 Machine inspection records	1
	6.3 In the maintenance toolbox (Not supplied)	1
	6.4 Operator use and adjustment	2
	6.4.1 Machine Settings and Adjustments	2
	6.4.2 Setting the cutting height using skids	2
	6.4.3 Shear bolt protection (If fitted)	3
	6.4.4 Setting slip clutch PTO (Option - if fitted)	3
	6.4.5 Transportation to work site	4
	6.4.6 Driving on Public Roads	4
	6.4.7 Cutting deployment and retraction	4
	6.4.8 Start-up	5
	6.4.9 General use – Grass cutting	5
	6.4.10 Stopping the Machine	5
7	Removal, Storage and Disposal	1
	7.1 Preparation for Storage	1
	7.1.2 Cleaning the Machine	1
	7.2 Parking	1
	7.3 Removal	2
	7.4 Disposal	2
8	Maintenance	1
	8.1 Regular Maintenance chart	1
	8.2 Maintenance Safety	1
	8.3 Lubricating Oil Precautions	1

8.4	Power Take Off (P.T.O.) Shaft	2
8.4.1	Seasonal slip clutch maintenance. (If fitted)	2
8.5	Driveline	3
8.5.1	Gearbox Mountings Bolts.....	3
8.5.2	Oil Level.....	3
8.5.3	Draining & Refilling.....	3
8.6	Blade bar.....	4
8.6.1	Blade bar Maintenance	4
8.6.2	Removal and replacement of Blade carrier assembly.....	4
8.6.3	Blade bar removal	4
8.6.4	Blades and blade bushes maintenance.....	4
8.6.5	Blade & Blade bush removal and replacement	4
8.7	Fastener Torque Guidelines	5
8.7.1	Specific Torque Settings	5
8.7.2	General Torque Settings	5
8.7.3	Converting chart between Measuring Systems.....	5
9	Trouble shooting.....	1
10	Warranty Information.....	1
10.1	Warranty policy	1
10.1.1	Warranty registration	1
10.1.2	Limited warranties	1
10.1.3	Remedies and procedures.....	2
10.1.4	Limitation of liability	2
10.1.5	Miscellaneous.....	2
10.2	How to make a claim	3
10.3	How to obtain the correct spare part numbers	3

1 Machine Description

1.1 Intended usage

The Spearhead Agricut 180 was developed for farms and small contractors, perfect for grasslands and paddocks.

The Spearhead Agricut 180 series is primarily designed for the topping of grass pasture land after grazing, or for thistle and weed control on agricultural land. The Spearhead Agricut 180 machines are not designed for grass mowing or for set-aside cutting along with brush/woodland clearance.

The Spearhead Agricut has a 1.80 metre cutting width that is suitable for use with tractors from 30 to 70 HP. The cutting height of the machine is manually adjustable and features a 'self-levelling' system to ensure the deck remains parallel irrespective of the cutting height.

The Spearhead Agricut range is designed for use on level, undulating or gently inclined ground and a duty cycle of 400 hours per annum.

In the interest of safety and for the protection of your mower you must never use this machine to perform tasks it was not designed to do.

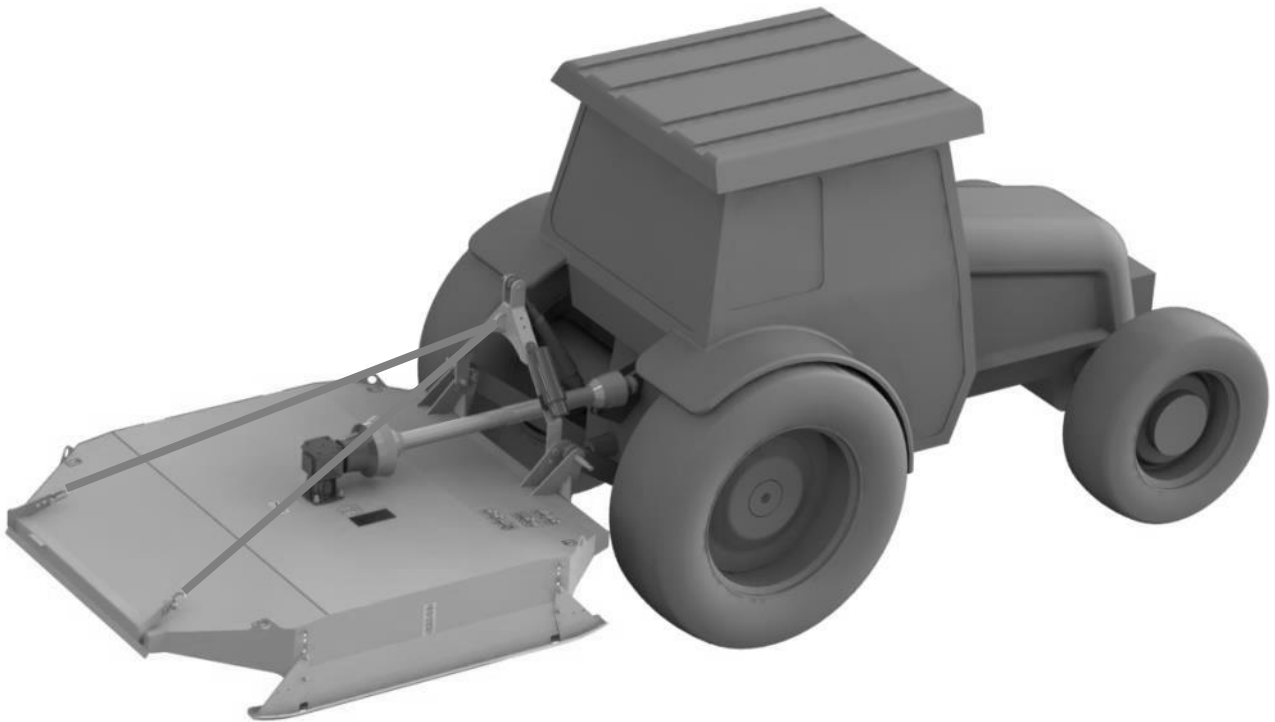

Figure 1.1 Spearhead Agricut 180

1.2 General arrangement

The layout and naming convention used throughout this manual are shown in Figure 1.2 below

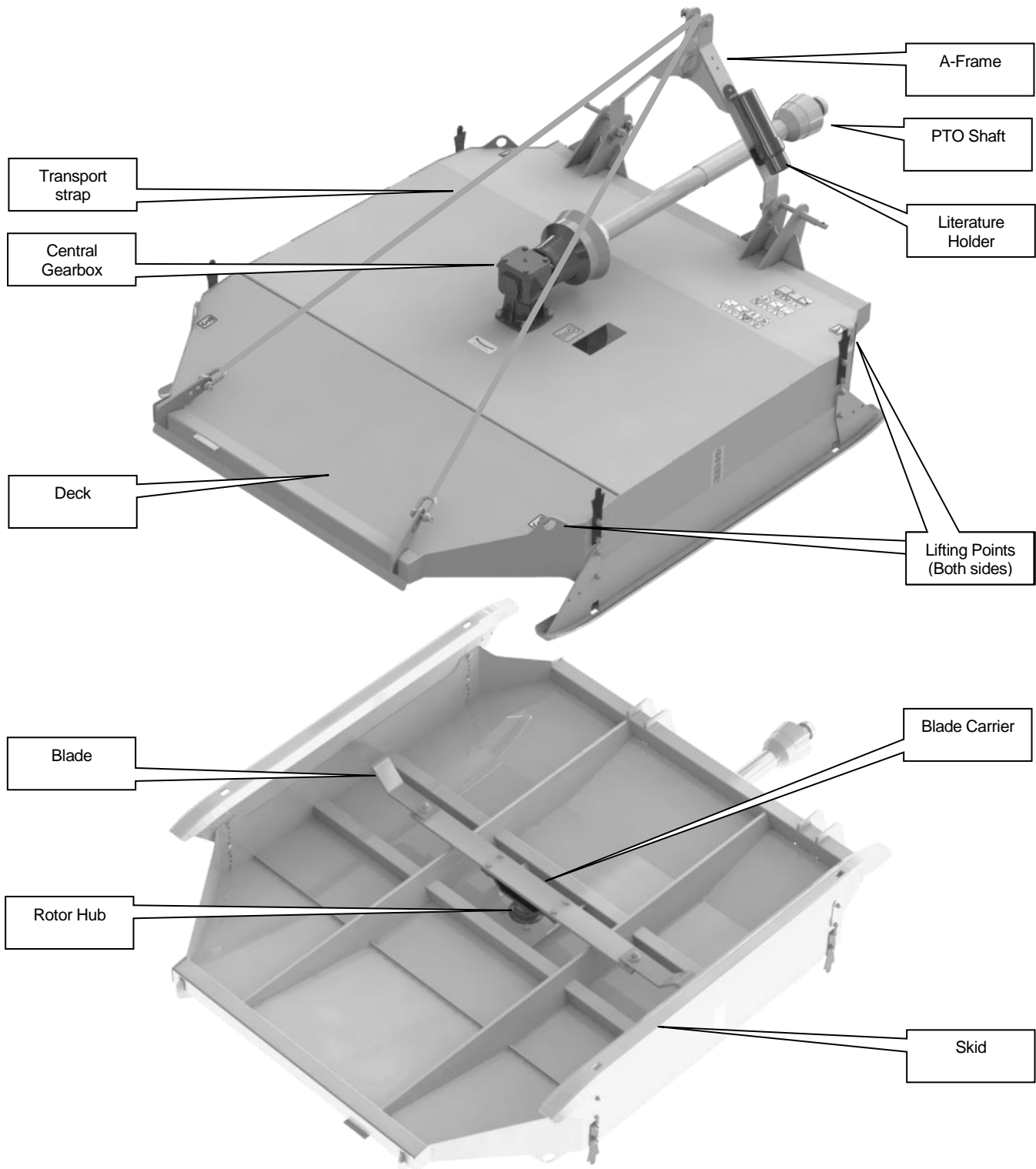

Figure 1.2

1.3 Machine rotation convention

The layout and naming convention used throughout this manual are as follows: For a clockwise output from the tractor unit, see Figure 1.3, the centre Gearbox has a clockwise cutting action; and the RH gearbox has an anti-clockwise cutting action.

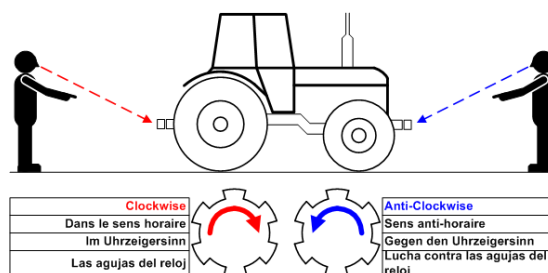

Figure 1.3

1.4 Machine general specification

SPECIFICATION DESCRIPTION	
Tractor Power Requirement (Minimum)	30 HP (22 kW)
Method of Attachment	3 Point Linkage via A-Frame
Splitter Gearbox Rated Input Power	N/A
Gearbox Rated Input Power	40 HP (29.4 Kw)
Cutting Width	1.80 m
Machine Width in Work Position (Overall Width)	1958.0 mm
Machine Width in Transport Position	1958.0 mm
Machine Height in Transport Position	1570.0 mm
Overall Machine Length	2330.0 mm
Machine Weight	330.00kg
Cutting Capacity (Maximum)	N/A
Cutting Height (Minimum / Maximum)	50.0 mm / 175.0 mm
Blade Tip Speed (Center Cutting Unit)	75 m/s
Blade Tip Speed (Wing Cutting Unit)	N/A
Wing Flex	N/A
Blade Overlap	N/A
Cutting Units/No. of Rotors	1
Number of Blade Carriers	1
Number of Blades	2
Number of Skids	2
Linkage Mounting	Cat. 1 & 2
PTO Speed	540 PTO
Wheels	N/A
Tyre Size	N/A
Tyre Type	N/A
Recommended Tyre Pressure	N/A
Shredder Blade Kit	N/A

Notes:

- (1) Spearhead Machinery constantly reviews and improves product designs and reserve the right to change this information. As a consequence actual machines may vary from specification. Contact your Spearhead Sales representative if you have any queries.
- (2) This specified geometric maximum is stated for information purposes only. It does not imply that it is safe or appropriate to cut material in this position. The actual safe maximum side cut height will depend on the width of the tractor that the implement is mounted to.
- (3) The transport width quoted is a half width and is measured to the PTO centre which is notionally assumed to be on the tractor centreline. As a consequence the full on road width is the quoted transport width plus half the tractor width plus (or minus) any mounting offset from the tractor centreline.
- (4) The transport depth is indicative and will vary with the specified tractor. This figure assumes a reference dimension of **766mm** between axle centre and lower link pin centre.
- (5) All dimensions are determined from computer models. As a result actual measurements may vary as a result of deflections due to weight. Tractor tyres will naturally compress on the working side of the tractor as the centre of gravity shifts. The amount is affected by tyre construction, age, inflation pressures and the use of local ballast weight. For example a 20mm compression of the cutting side rear tyre will be magnified by the offset reach which will have an effect on the actual cut height.

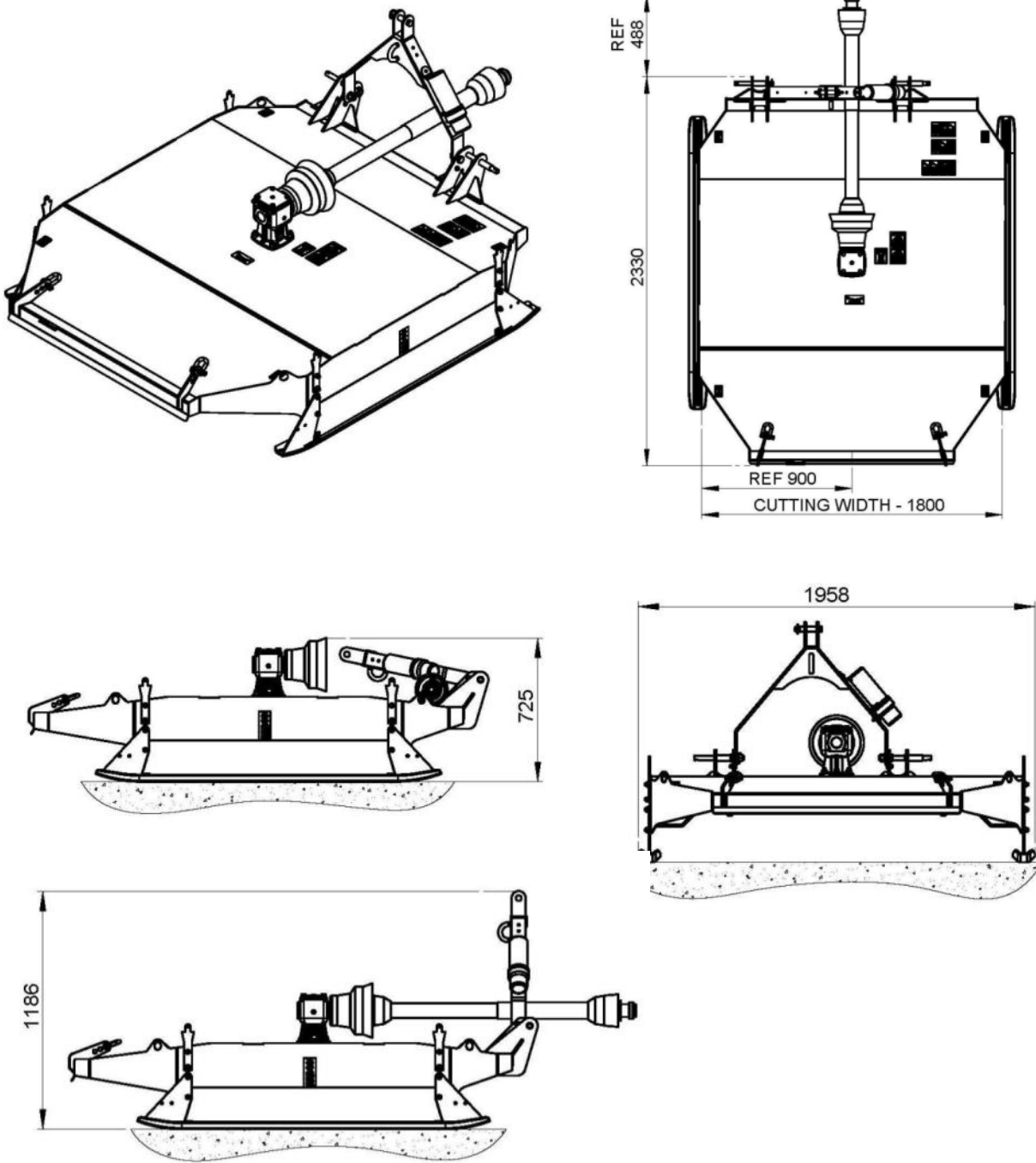

Figure 1.3 Cut and Deck dimensions

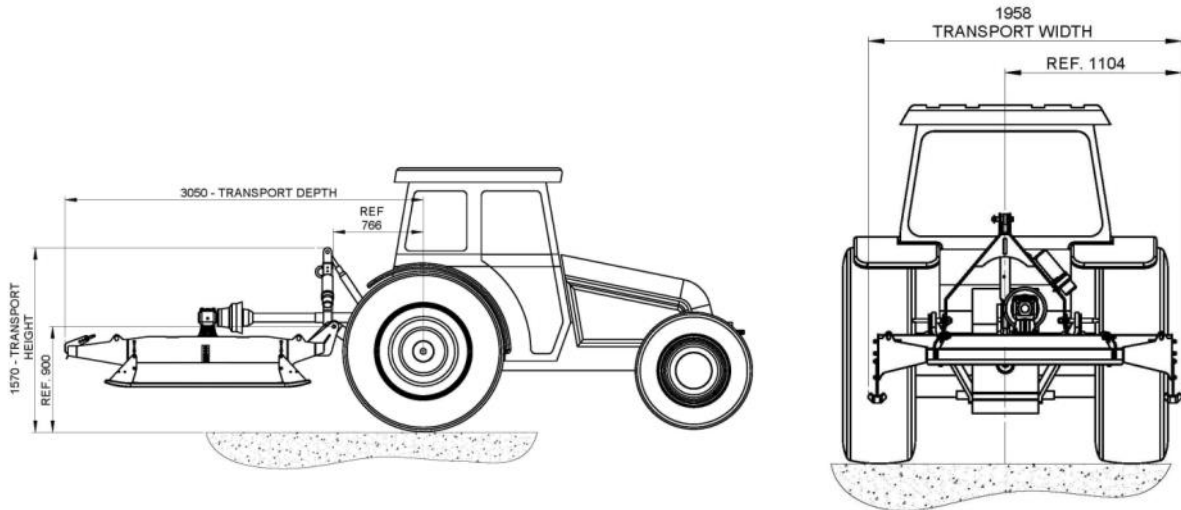

Figure 1.4 Transport position

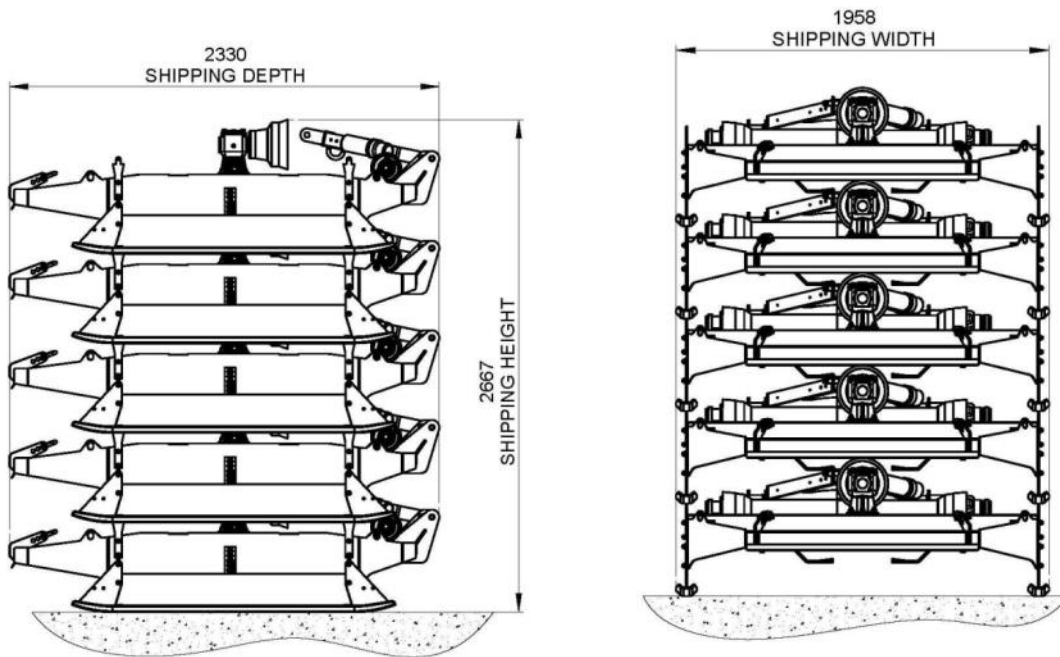

Figure 1.5 Shipping position

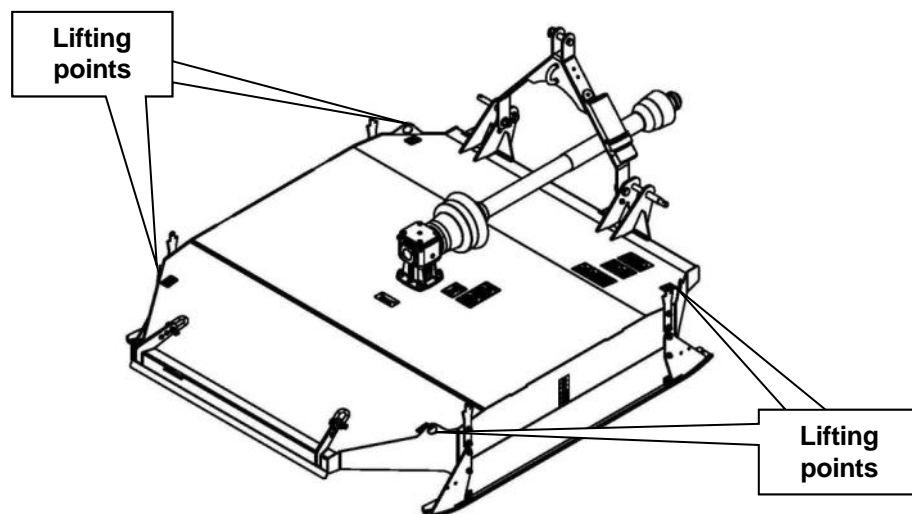

Figure 1.6 Lifting points

2 Safety

2.1 Safe operation

This user manual should be considered as part of the machine. The operator should read the following pages carefully and become familiar with the contents before starting work. Familiarity with the instruction manual is an essential part of training for a competent user. Operators must be competent and fully capable of operating this machine safely and effectively before attempting to use it in a public place.

Every employee should receive regular training on how to use this machine (at least once a year), in accordance with the guidelines published by the employer's insurance. Untrained or unauthorized personnel must not use this machine.

In the interest of safety, please make sure that the instructions mentioned above are made known to all your employees who must use the equipment. We recommend that the use of this equipment be limited to qualified operators. Persons under the age of sixteen must not use the machine and must stay away from the place where they are used.

2.2 Safety warnings

The operator must read, understand and follow all of the Safety instructions. Serious injury or death may occur unless care is taken to follow the warnings and instructions provided. The level of safety is indicated in three levels and the following notation is used throughout this operator instruction book;



DANGER! Level 1; alerts for imminent death or critical injury.



WARNING! Level 2; warns of serious injury or possible death.



CAUTION! Level 3; indicates possible injury.

Never operate the tractor or machinery until you have read and completely understand this manual and the tractor operator's manual and each of the safety messages found in the manuals and those displayed on the tractor and implement.



DANGER! DO NOT attempt any maintenance of or adjustment to the machine while it is running. Before carrying out any work on the machine follow the three safety instructions below:

- PUT THE PTO OUT OF GEAR
- STOP THE TRACTOR ENGINE
- LOWER THE CUTTING UNIT ON TO THE GROUND



DANGER! At all times ensure that the PTO shaft guard is in position, securely fitted and in good condition and that the tractor PTO shaft shield is fitted. Always replace any damaged guards and shields.



DANGER! Do not enter the working zone of the PTO shaft. It is dangerous to approach the rotating parts of the machine.



DANGER! Before maintaining and working on the machine always stop the tractor, switch off the tractor engine, remove the ignition key and remove the PTO shaft. Do not work under any machine raised on hydraulics unless it is supported by a solid safety support.



DANGER! Never clean or adjust PTO driven equipment with the tractor engine running. Kill the engine and pocket the key before attempting any maintenance on the machine.





DANGER! All guards, bands, deflectors, driveline shields and gearbox shields should be used and maintained in good working condition at all times. They should be carefully inspected daily for missing or broken cable, chain links, shields or guards. Missing, broken or worn items must be replaced before attempting to use the machine to reduce the possibility of injury from thrown objects or entanglement.





DANGER! Keep a careful watch for passers-by who may inadvertently get in the way of cut material being thrown from the machine. These machines are capable under adverse conditions of throwing objects great distances at high velocity. Stop the blades until all people are well clear.

 **DANGER!** **AVOID WIRE.** It can be extremely dangerous if wire catches in the blades of the machine, and every care must be taken to ensure this will not happen. Inspect the working area before commencing. Remove all loose wire and obstructions and clearly mark those that are fixed so that you can avoid them. Any unusual noise from the cutting unit area indicates that the blades may have been fouled by an obstruction. A visual indication that wire has become entangled may be a sudden movement of the vegetation ahead of the machine. In any such event **STOP** the tractor engine **INSTANTLY**. On no account move the machine until blades have completely stopped. **NEVER UNDER ANY CIRCUMSTANCES** run the machine in reverse to 'clear itself'. When the machine has stopped, inspect it and remove any obstruction that may be present. If working under a raised machine, ensure that it is safely supported. Before working on the machine always stop the tractor engine and remove the ignition key.

 **DANGER!** These machines are capable under adverse conditions of throwing objects great distances at high velocity. **CHECK** the blades for wear and the attachment bolts for tightness every day during work. A few moments whenever the machine is stopped (e.g. whenever removing obstructions) will help reduce blade wear or loss.

 **DANGER!** **ANY UNUSUAL NOISE** from the cutting unit area indicates that the blades may have been fouled by an obstruction. A visual indication that wire has become entangled may be a sudden movement of the vegetation ahead of the machine. In any such event **STOP** the tractor engine **INSTANTLY**. On no account move the machine until blades have completely stopped. **NEVER UNDER ANY CIRCUMSTANCES** run the machine in reverse to 'clear itself'. When the machine has stopped, inspect it and remove any obstruction that may be present. If working under a raised machine, ensure that it is safely supported. Before working on the machine always stop the tractor engine and remove the ignition key.

 **DANGER!** Do not operate with wings raised off the ground. Operating with the wings raised exposes the blades and can cause objects to be thrown and there is also danger of entanglement in or being hit by rotating blades.

 **DANGER!** Never transport the machine or attempt maintenance with the blades running. Serious injury or even death can result from contact with rotating blades.

 **DANGER!** Keep your forward speed to a level appropriate to the operating conditions. High-speed manoeuvres are very dangerous, particularly on uneven ground where there is risk of overturning.

 **DANGER!** When the wings are folded for transport, the centre of gravity is raised, and the possibility of overturn is increased. Turn slowly and with extra care on hillsides. Overturning the mower could cause the mower to overturn the tractor and vice versa. Never fold wings on a hillside, the mower may overturn

 **DANGER!** Be particularly careful in transport. Turn curves or go up hills only at a low speed and at a gradual steering angle. Ensure that at least 20% of the tractor's weight is on the front wheels to maintain safe steering. Slow down on rough or uneven surfaces.

 **DANGER!** DO NOT carry passengers on either the tractor or the mower - falling off can kill.

 **DANGER!** Do not mount or dismount the tractor or machine while it is moving. Mount or dismount only when stopped – falling off can kill.

 **DANGER!** Do not operate this Equipment with hydraulic oil leaking. Oil is expensive, and its presence could present a hazard. **Do not check for leaks with your hand!** Use a piece of heavy paper or cardboard. High-pressure oil streams from breaks in the line could penetrate the skin and cause tissue damage including gangrene. If oil does penetrate the skin, have the injury treated immediately by a physician knowledgeable and skilled in this procedure.

 **DANGER!** Never leave the machine in the raised transport position – the machine could fall inadvertently and cause injury or death to anyone who might be under the machine.

 **DANGER!** Never run a tractor engine in a closed building without adequate ventilation. The exhaust fumes can be hazardous to your health.

 **DANGER!** Never work under the mower deck, framework or any raised component unless the mower has been securely supported and blocked using suitable substantial items to prevent sudden or inadvertent falling which could cause serious injury or even death.



DANGER! Operate the mower only with a tractor equipped with an approved 'roll over protection system (ROPS). Always wear your seat belt. Serious injury or even death could result from falling off the tractor – particularly during a turnover when the operator could be pinned under the ROPS or the tractor.



DANGER! The rotating parts of this machine have been designed and tested for rugged use. However, they could fail upon impact with heavy solid objects such as steel guardrails and concrete abutments. Such impact could cause the broken objects to be thrown outward at very high velocities. To reduce the possibility of property damage, serious injuries, or even death, never allow the cutting blades to contact such objects.



WARNING! Before starting, checks on tractor and machine must be carried out as regards: functionality, road safety, accident prevention rules.



WARNING! Before leaving the tractor stopped with the machine attached, proceed as follows: Disconnect the power take off, lower the machine steadily to the ground (with the hydraulic lift) Apply the hand brake and, if the ground is steeply sloping, wedge the tractor. Take out the starting key. Immediately replace any safety sign, or any missing or damaged decal.



WARNING! CHECK the blades for wear and the attachment bolts for tightness every day during work (see Maintenance section). A few moments whenever the machine is stopped (e.g. whenever removing obstructions) will help reduce blade wear or loss.



WARNING! Do not transport unless wings are well secured in the transport position. Wings that are not well secured can fall during transport, causing serious damage to the tractor and mower and possibly causing the operator or passers-by to be injured or killed.



WARNING! During checks or repairs, make sure nobody could start the machine by mistake.



WARNING! Ensure only one person operates the machine at any one time.



WARNING! Missing or damaged guards must be replaced immediately.



WARNING! Blades will continue to rotate for some time after the tractor PTO has stopped.



WARNING! Extreme care should be taken when operating near loose objects such as gravel, rocks, wire, and other debris. Inspect the area before mowing. Foreign objects should be removed from the site to prevent machine damage and/or bodily injury or even death. Any objects that cannot be removed must be clearly marked and carefully avoided by the operator. Stop mowing immediately if flails strike a foreign object. Repair all damage and make certain the rotor shaft is still balanced before resuming cutting operations. NOTE: Where grass and weeds are high enough to obscure debris that could be struck by the blades, the area should be inspected, and debris removed, mowed at an intermediate height, and re-inspected closely to remove any remaining debris and mowed again at the desired final height. In addition to the safety aspect of this procedure it will also reduce wear and tear on the mower drive-train, spread cut materials better, eliminate 'streaking' and make the final cut more uniform.



















WARNING! Never attempt to lubricate, adjust, or remove material from the machine while it is in motion or while tractor engine is running. Make sure the tractor engine is off before working on the Implement.



WARNING! Never connect the power take off unless the tractor engine is stopped.



WARNING! When unhitching the mower select a firm level site on which to park it - lower machine to the ground fully (fit and adjust the hitch support prop on high hitch machines) and 'chock' the wheels. Remember to disconnect hydraulics, lighting plug and PTO shaft (use the PTO support) before driving the tractor away. Stow hoses and electrical cable neatly off the ground to avoid moisture or dirt contamination.

-  **WARNING!** For machines fitted with hitch adjustment mechanisms, never un-couple the machine without using the hitch support jack. The hitch is very heavy. Attempting to lift the hitch without using the jack could cause strains. Allowing the hitch to fall suddenly and unexpectedly could result in crushing injury. Use the support jack for lifting the mower only. Overloading the jack can cause failure with possible serious bodily injury or even death.
-  **WARNING!** Periodically inspect all moving parts for wear and replace when necessary with authorised service parts. Look for loose fasteners, worn or broken parts, and leaky or loose fittings. Make sure all pins have cotter pins and washers. Serious injury may occur from not maintaining this machine in good working order.
-  **WARNING!** Where hydraulic rams are fitted, release hydraulic pressure from the rams before attempting maintenance. Lower the machine to the ground and lower any wings or securely block them up, disengage the PTO and turn off the engine.
-  **WARNING!** The operator and all support personnel must wear appropriate Personal Protective Equipment. i.e. safety clothing, safety glasses and protective footwear at all times for protection from injury by objects thrown from the machine.
-  **WARNING!** Transport the machine only at safe speeds. Serious accidents and injuries can result from operating this equipment at unsafe speeds
-  **WARNING!** While the tractor is running all personnel should keep well clear of the area around the machine as there are numerous crushing, shearing, impact dangers caused by the machine operation.
-  **WARNING!** Beware of dust. Keep tractor cab windows and doors closed at all times to reduce the risk of dust and flying debris from entering. In dusty conditions the use of a suitable mask, to EN 149, is strongly recommended.
-  **WARNING!** The machine must only be lifted by personnel with appropriate lifting qualifications. The lifting points are clearly marked with 'hook' symbols.
-  **WARNING!** Always ensure the tractor front end weight is sufficient to give proper front wheel contact and safe steering when machine is raised on tractor hydraulics.
-  **WARNING!** The operators, manual must be kept with the machine to be available for quick and easy reference.
-  **WARNING!** Beware of bystanders and animals. Before starting the tractor-engine and moving off, check that it is safe to do so. Never operate the machine with bystanders or animals near or on the machine or tractor. Never stand in or walk through the flow of any material being discharged. Never stand between tractor wheels and the machine.
-  **WARNING!** Do not start or carry out maintenance on this machine until you have read all the safety precautions to be observed and until you fully understand the controls and functions of the machine as detailed in the following sections. If you do not understand any part of this manual, ask your dealer for assistance.
-  **WARNING!** Always fit the PTO shaft guard & check chains. P.T.O. guard check chains must always be attached to a suitable point on the tractor and machine to prevent movement of the outer plastic shields.
-  **WARNING!** It is the owner's/operator's responsibility to ensure that the machine is fitted with correct lighting and safety markings when moving it on the public highway during the hours of darkness.
-  **WARNING!** Never operate the machine with any of the rotor blades missing or damaged. To prevent injury, when changing blades, always block the rotor to stop it rotating.
-  **WARNING!** Never operate the machine with any parts missing. Check the machine regularly for loose or damaged parts. Pay attention to the condition of all safety guards. Always use genuine Spearhead replacement parts in the interest of safety. Failures caused by the use of unapproved replacement parts will not be covered by our warranty, nor will any liability be accepted for damages or injury thus incurred.



WARNING! Never stand on the machine, attempt any maintenance or adjustments with the tractor engine running or P.T.O. shaft connected.



WARNING! Never wear loose fitting or ragged clothing. Avoid injury - always wear clothing which cannot get caught in machinery.



WARNING! Before leaving the tractor seat always engage the brake and/or set the tractor transmission in parking gear. Disengage the PTO, stop the engine, remove the key and wait for all moving parts to stop. Place the tractor shift lever into a low range or parking gear to prevent the tractor from rolling. Never mount or dismount a moving tractor. Operate the tractor controls from the tractor seat only.



WARNING! Ensure all necessary signs are correctly displayed, and clearly visible, when working or transporting on or near a public highway. (Contact your Local Highway Authority to ensure you are fully conversant with your responsibilities on this subject). Use flashing warning lights when working or transporting on or near a public highway to indicate to other road users a potential hazard. Always abide by local traffic regulations.



WARNING! Ensure the machine is regularly inspected for loose fasteners, worn or broken parts and loose or leaky fittings. Ensure all pins are fitted with cotter pins and washers. Serious injury can result from failure to maintain this machine in good working order.



WARNING! Ensure you maintain all safety decals in good readable condition. If a Decal should for any reason become illegible order a replacement immediately before permitting the machine to be used.



CAUTION! Both the operator and the maintenance fitter must know the machine well, especially regarding dangers resulting from improper use or incorrect repairs.



CAUTION! In transport, reduce speed, especially on bumpy roads.



CAUTION! When driving on public roads, respect all road rules in force.



CAUTION! Spearhead Machinery will not be held responsible for failure caused by the use of incorrect lubricants. For further information, refer to the lubrication section of this manual.



CAUTION! Pay special attention when working with the machine, not to touch fixed objects, such as road drain, walls, shafts, kerbs, guard rails, tracks etc. This could cause damage to blades and cause debris to be thrown out at very high speed.



CAUTION! If wires, ropes or chains should get entangled in the blades, stop immediately, to prevent damage or dangerous situations; stop the blades and the tractor, take out the ignition key. Put working gloves on; clear the blades with the aid of pliers or shears.



CAUTION! Ensure hydraulic pipes are carefully and correctly routed to avoid damage by chaffing, stretching or pinching and that they are held in place with the correct fittings.



CAUTION! Always follow the manufacturer's instructions for attachment and removal of the machine from the tractor.



CAUTION! Check that the machine fittings and couplings are in good condition.



CAUTION! Ensure the tractor meets the minimum weight recommendations of the machine's manufacturer and that ballast is used as necessary.



CAUTION! Use clear suitably sized warning signs to alert others to the nature of the machine working within that area. Signs should be placed at both ends of the work site. (It is recommended that signs used are of a size and type specified by the Department of Transport and positioned in accordance with their, and the Local Highways Authority, guidelines).

2.3 Stopping in an emergency

In an emergency bringing the blades to a stop requires familiarity with the controls fitted to the tractor.

To stop the blades in an emergency, use the tractor 'ENGINE STOP' control. **NOTE:** The use of the tractor 'ENGINE STOP' control must **only** be done in an emergency. Its use to stop the machine can cause damage. After an emergency stop of the machine; ensure that the PTO is disengaged before restarting the tractor.

2.4 Dangers due to overhead power lines

There are significant dangers involved when working in the vicinity of Overhead Power Lines (OHPL's);



DANGER: All operators must read the following information and be aware of the risks and dangers involved when working in the vicinity of Overhead Power Lines (OHPL's).



WARNING! Fatal electrocution can occur without contacting a power line. Due to the high electrical potential between the conductors and the ground a flash over can occur from the power line to any conducting medium within range. Steel mowers are ideal conductors.

Wherever possible the safest option is always to avoid working in areas close to OHPL's. Where unavoidable, all operators must perform a risk assessment and implement a safe procedure and system of work, see section 2.4.1 below.

All operators should perform a risk assessment before operating any arm mower within 10m horizontal distance of any OHPL's. If you are unsure do not work in the area. Never put yourself or others at risk.

2.4.1 Risk assessment

Before starting to work near OHPL's you should always assess the risks. The following points should be observed;

- **Know** the risks of contacting OHPLs and the risk of flashover.
- Always **find out** the maximum reach height for your machine mounted on its tractor, see 'Machine general specification in chapter 1 for guidance.
- Always **find out** the location and route of all Power Lines within the work area.
- Always **find out** the operating voltage of all Power Lines within the work area.
- Always **contact** the local Distribution Network Operator (DNO) who will be able to advise you on the operating voltage, exclusion zones, the minimum safe working distance and any additional precautions required.
- **Never** attempt to operate the machine within an exclusion zone.
- Always **work with extreme caution and plan your work ahead** to avoid high risk areas.
- **If doubt exists** do not work in the area – never risk the safety of yourself or others

Further information and leaflets on this and other agricultural safety subjects are available on the 'Health & Safety Executive' website at the following address: www.hse.gov.uk/pubns/agindex.htm

2.4.2 Emergency Action for Accidents Involving Electricity

- Never touch an overhead line - even if it has been brought down by machinery or has fallen. Never assume lines are dead.
- When a machine is in contact with an overhead line, electrocution is possible if anyone touches both the machine and the ground. Stay in the machine and lower any raised parts in contact or drive the machine out of the lines if you can.
- If you need to get out to summon help or because of fire, jump out as far as you can without touching any wires or the machine keep upright and away.
- Get the electricity company to disconnect the supply. Even if the line appears dead, do not touch it - automatic switching may reconnect.

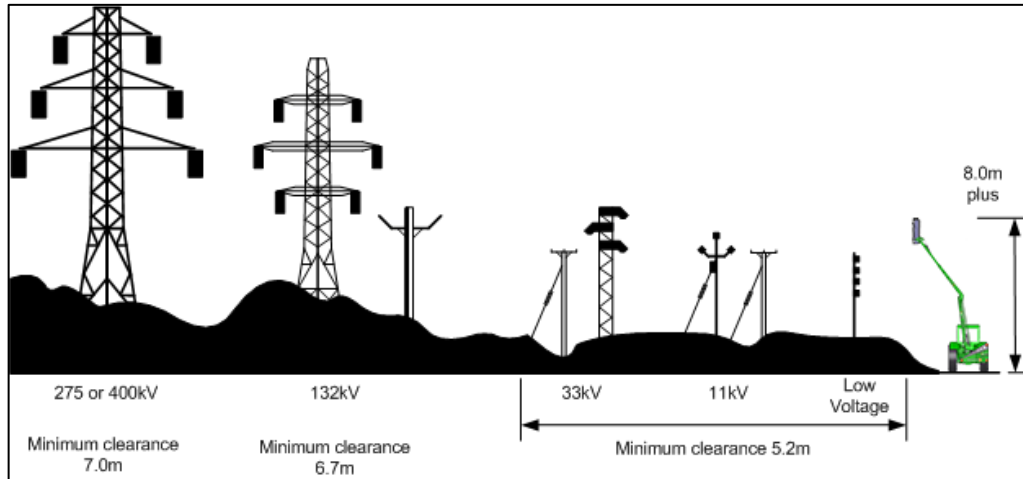

Figure 2.1 - Minimum heights for overhead power lines

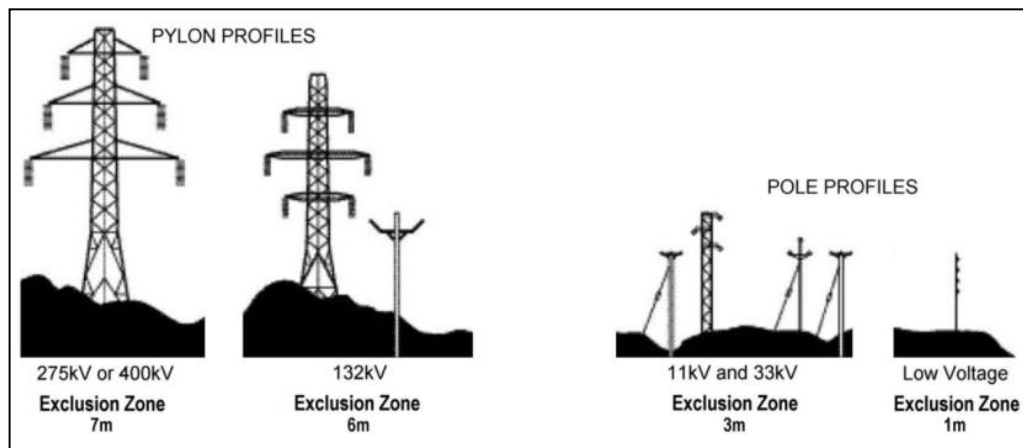

Figure 2.2 - Absolute Minimum Exclusion Zones for Specific Overhead Power Lines

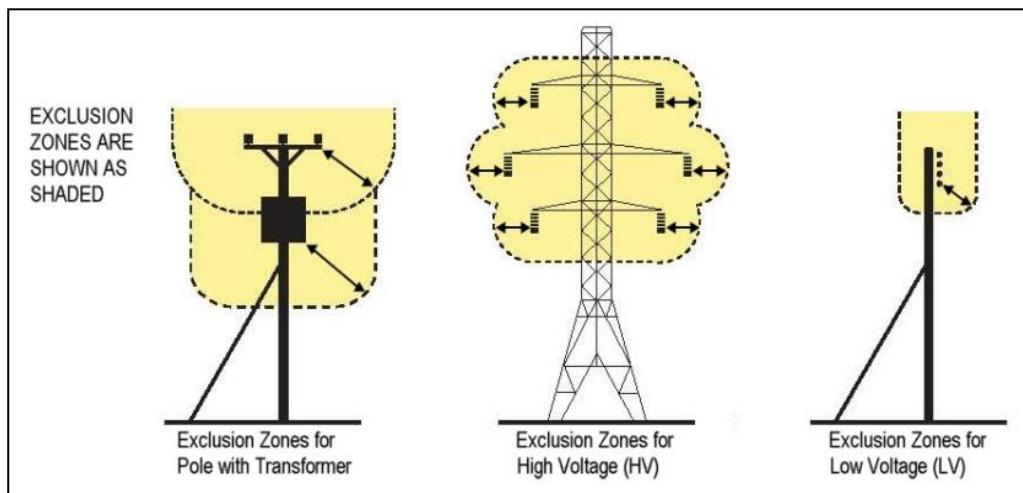

Figure 2.3 - Definitions of Exclusion Zones

2.5 Noise

The equivalent daily personal noise exposure from this machine, measured at the operator's ear, is within the range of 80-85dB when used in conditions where the load fluctuates between zero and maximum. This applies when the machine is attached to a tractor fitted with a quiet cab and used in accordance with the operating instructions in a generally open environment. At equivalent daily noise exposure levels of between 85 and 90dB, suitable ear protectors are recommended.

2.6 Personal Protective Equipment

When working in an unsealed cab or where windows and apertures are open to the environment, operators are advised to wear suitable ear protectors.

When handling cutting surfaces or hydraulic equipment, operators are advised to wear suitable gloves.

When clearing blockages, clearing wire, or working with pressurised hydraulic components, operators are advised to wear suitable eye protection.

When working at the work site, but off the tractor unit, operators are advised to wear a 'high-viz' garment.

2.7 Guards

 **DANGER!** For safe operation it is essential that that all guards must be kept in position on the machine whenever the machine is running. Spearhead Machinery disclaim all responsibility for any damage or injury arising as a result of guards being removed, or of guards other than of Spearhead manufacture having been fitted, or of operation of the machine other than in accordance with these instructions.

 **WARNING!** Inspect guards twice daily or immediately damage is suspected. Always replace guards that have damage or wear which could impair their performance

 **WARNING!** Ensure that chains/blades and all fixings are genuine components supplied by the manufacturer specifically for the machine and are securely attached with no parts missing or damaged.

 **WARNING!** Ensure chain wear does not exceed the following limits;

- For 10mm chains all links must have a minimum thickness of 8mm.
- For 13mm chains all links must have a minimum thickness of 10mm.
- Ensure all chains are the same length to maintain balance of the cutting unit.

2.8 Tractor stability

Due to the design of mowers and the work they undertake, it is essential to ensure that the tractor is stable during work and transport in order to eliminate any risk of loss of directional control, imbalance or overturning.

Before driving in transport, check that the front wheels of the tractor are both on the ground. It is advisable to have a helper to check this. Check that the tyre shows evidence of bearing load. This is especially important to ensure forward directional control at speed on an undulating terrain.

If the front tyres lift, add ballast weights to the front of the tractor. If ballast weights have been added to the tractor, check that the plated tractor axle loads have not been exceeded.

 **DANGER!** Keep your forward speed to a level appropriate to the operating conditions. High-speed manoeuvres are very dangerous, particularly on uneven ground where there is risk of overturning.

 **DANGER!** When the wings (if fitted) are folded for transport, the centre of gravity is raised, and the possibility of overturn is increased. Turn slowly and with extra care on hillsides. Overturning the mower could cause the mower to overturn the tractor and vice versa. Never fold wings on a hillside, the mower may overturn.

 **DANGER!** Be particularly careful in transport. Turn curves or go up hills only at a low speed and at a gradual steering angle. Ensure that at least 20% of the tractor's weight is on the front wheels to maintain safe steering. Slow down on rough or uneven surfaces.

 **DANGER!** Operate the mower only with a tractor equipped with an approved 'roll over protection system (ROPS). Always wear your seat belt. Serious injury or even death could result from falling off the tractor – particularly during a turnover when the operator could be pinned under the ROPS or the tractor.



WARNING! Failure to have sufficient load over the front axle or to drive at inappropriate speeds on undulating terrain may result in a loss of directional control.



WARNING! Transport the machine only at safe speeds. Serious accidents and injuries can result from operating this equipment at unsafe speeds



WARNING! Always ensure the tractor front end weight is sufficient to give proper front wheel contact and safe steering when machine is raised on tractor hydraulics.



CAUTION! In transport, reduce speed, especially on bumpy roads.

IMPORTANT: When transporting on the highway, it is the responsibility of the operator to obey all relevant local highway laws.

2.9 Working on inclined ground

The ballast instructions in section 2.8 are sufficient for level ground operation.

Be aware that when working on inclined ground changes in the tractor centre of gravity can adversely affect the overall stability.

There is naturally a limit to a safe amount of ballast compensation that can be applied for a given tractor unit and a given incline. If compensating ballast is applied and the compensated axle must be driven on the public highway to reach the work site the operator should ensure that the plated axle load is not exceeded.

Remember, a mower represents a significant mass which can generate a significant amount of inertia when moved at speed. Stopping this inertia suddenly can induce overturning reactions.



DANGER! When working on inclined ground avoid any high speed hydraulic manoeuvres which could cause overturning.

2.10 Working on embankments

Sudden potholes at speed can quickly cause the tractor to change direction. At the same time the weight of the implement may try to lift the front axle. This is a potentially lethal combination when working along narrow embankments or dykes and can lead to overturning and potential drowning.

When working on top of embankments it is very important to have sufficient forward stability to ensure rapid steering control. Spearhead recommend 20% forward stability. This means that at least 20% of the total vehicle weight is acting on the steering axle under normal level conditions.



DANGER! When working on raised embankments ensure sufficient weight is on the steering wheels.

3 Safety Decals

Safety decals are located on various points of the machine. To identify the correct location, refer to the serial number specific Parts book supplied with your machine. Safety decals can be identified by the yellow upper panel depicting the hazard, and the lower white panel indicating means of avoidance or precautions to be taken. These decals have no text. It is essential that all operators and personnel associated with the machine fully understand their meanings, which are shown in Figure 3.1 below.

Safety decals should always be kept clean and legible. Any safety decals which are found to be missing or illegible should be replaced.

The safety instructions in section 2.0 and the safety decals fitted to the machine are designed to draw the operator's attention to the potential dangers that exist while using the machine. Certificated operator training is recommended before use.

BE ALERT, PAY ATTENTION – SOMEONE'S LIFE MAY BE AT STAKE!

	<p>Read and Comply with Operator's Manual Read and understand the Operator's Manual before attaching and operating this machine.</p>		<p>Stop Tractor before Work on Machine. Always let the tractor come to a stop, and remove the starter key before you adjust, lubricate, repair or carry out any maintenance work on the machine.</p>	
	<p>Keep a Safe Distance from the Machine. Danger of flying objects when machine is working. Bystanders must keep a safe distance when the machine is being used.</p>		<p>Beware of Rotating Blades. Danger of cutting or severing of limbs under covered rotating parts. Do not reach or probe under the machine when it is driven by the tractor.</p>	
	<p>Machine Lifting Points. When lifting the machine with other than approved tractor attachment points, use the marked lifting points for safe and balanced lifting.</p>		<p>Input PTO Speed. The rated PTO speed for this machine is 540 rpm. Under no circumstances should this speed be exceeded.</p>	
	<p>Danger of entanglement. Keep clear of machine when in operation.</p>		<p>Danger of entanglement keep clear of machine when in operation.</p>	
	<p>Keep all nuts tight</p>		<p>Do not work under unsupported machine.</p>	
	<p>Danger of crushing stay clear of zones</p>		<p>Danger do not operate machine when raised.</p>	
	<p>Cut height setting in millimetres</p>	<p>IMPORTANT Time Blade Carriers Perpendicular To Each Other</p>	<p>BLADE ROTATION</p>	<p>Blade rotation direction indicator decals</p>
		<p>IMPORTANT: Time blade carriers perpendicular to each other</p>	<p>BLADE ROTATION</p>	

Figure 3.1

4 Lubricants

4.1 Filling the Gearbox

The gearbox capacities are shown in Figure 4.1. Always check the gearbox oil levels before use and top up if necessary, see maintenance section. Use oils compatible with classification API GL-5, see Figure 4.1.



WARNING! Only use oil which is compatible with the above classification.

Machine type	Gearbox	Recommended oil type	Capacity (Litres)
Agricut 180 in-line	90-degree blade drive box	EP 80W-90	1.1

Figure 4.1

5 Installation

5.1 Unpacking the machine

Check that the machine instruction manual is in the document holder attached to the machine.

The operator's manual should be regarded as part of the machine. Suppliers of both new and second-hand machines are advised to retain documentary evidence that this manual was provided with the machine. Check that the serial number has been entered inside the front cover of this manual. Add it appropriately if necessary. The serial number plate is fixed to the main mower deck mower to the linkage mounting. Always quote these numbers in any correspondence with a dealer.

5.1.1 Lifting the machine



WARNING! Only personnel experienced in lift and hoist operation should be involved in lifting machines.

The approved lifting points are illustrated in the machine general specification section in chapter 1 – 'Machine description'. Check that the correct lifting points are used to suit the machine's configuration, as the centre of gravity will change if for example a side shift position or wing deployment position is different per lift. - Exercise caution!

Use only the approved lifting points shown, and marked on the machine with the lifting decal, see Figure 5.1. Also ensure any lifting equipment is capable of lifting the machine mass indicated in Section 1.4 Machine general specification.



Figure 5.1



WARNING: Only use approved lifting equipment which is correctly fastened to the machine - this will increase your personal safety. Failure to follow the safety instructions could result in accidents and serious injuries.



WARNING: Before attempting to access the underside of the machine, ensure it is adequately and safely supported. Do not rely on the tractor's hydraulics. Use safety supports that are capable of supporting the machine mass indicated in Section 1.4 Machine general specification.

On despatch from the factory the rotors and blades of the machine will be secured with restraining wires and/or cable ties to stop them moving during delivery; these restraining wires must be removed before using the machine.

Locate and remove the 'Power Take-off Shaft' (PTO) from its shipping position, and temporarily store it in a place of safety.

If fitted, remove the stacking transport legs, see Figure 5.2a.

With the machine suitably supported, remove all rotor and blade restraining wires and/or ties, see Figure 5.2b. Inspect the underside of the machine to ensure it is undamaged, and check all blades rotate freely and do not foul on the body.

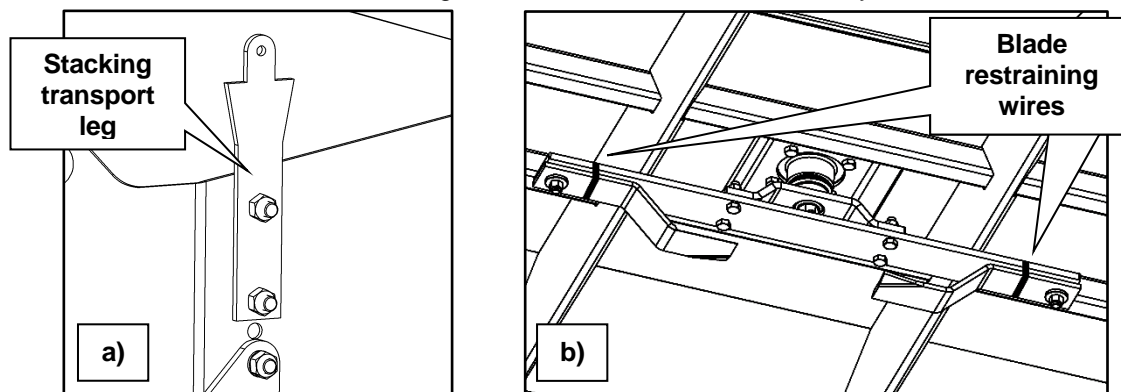

Figure 5.2

5.2 Tractor preparation



WARNING: Ensure that all operators have read and thoroughly understood all the safety procedures. For further information refer to the relevant sections of this manual.



WARNING: When connecting the machine to a tractor there is a risk of personal injury. Failure to follow the safety instructions could result in serious injuries to either yourself or others. Therefore, when connecting the machine and the tractor you should:

- a) Make sure the tractor cannot roll.
- b) Make sure that the tractor and the machine have compatible category attachments.
- c) Never stand between the tractor and the machine during attachment.
- d) Use the hydraulic three-point linkage slowly and carefully.
- e) When carrying out an attachment you must make sure that the machine is placed on a firm and level surface.

5.2.1 Tractor requirements

Before fitting the machine to the tractor ensure that the specification of the tractor meets the requirements listed below.

Tractor has a PTO output shaft which conforms to the 'Machine general specification' in chapter 1.0.
 Tractor has a PTO output speed which conforms to the 'Machine general specification' in chapter 1.0.
 A tractor top link is available (if required.)

Once the machine has been mounted to the tractor unit check the following;

The correct amount of fore/aft stability ballast has been added to the tractor front weight tray. The amount will vary depending on type of tractor used and prevailing conditions.

The correct amount of lateral stability ballast has been added to the rear wheel opposite to the side shift movement (if available). The amount will vary depending on type of tractor used and prevailing conditions.

NOTE: Some Spearhead machines are capable of being deployed on both sides of the tractor, in such case lateral ballast may be required on both rear wheels.

Once the machine is mounted to the tractor and the tractor is correctly ballasted ensure that the maximum axle loads for the tractor have not been exceeded. Failure to meet this requirement may render the operator liable for infringement of public highway regulations.

Ensure that the tyres fitted to the tractor are correctly rated for the total working weight. **NOTE:** When the cutting unit is fully side shifted the load on the rear tyre on the cutting side increases.

Spearhead does not endorse the use of water ballast within tyres as this can have adverse effects on fore aft stability at speed.

Check the run of the PTO for clearance. If necessary, remove the tractor drawbar or position it to one side so it does not foul on the PTO shaft. Redeploy or remove any items which are likely to contact the PTO in operation.

The machine is connected to the tractor on the 3-point hitch and will accept either CAT I or CAT II linkages. The tractor must also be equipped with a levelling box. If the tractor is fitted with a swinging drawbar, this should be set in its shortest mode or removed completely. The tractor should be equipped with a six-splined PTO.

5.3 Attaching the machine

Attachment of the machine should be performed on a firm level site - the procedure for attachment is as follows;

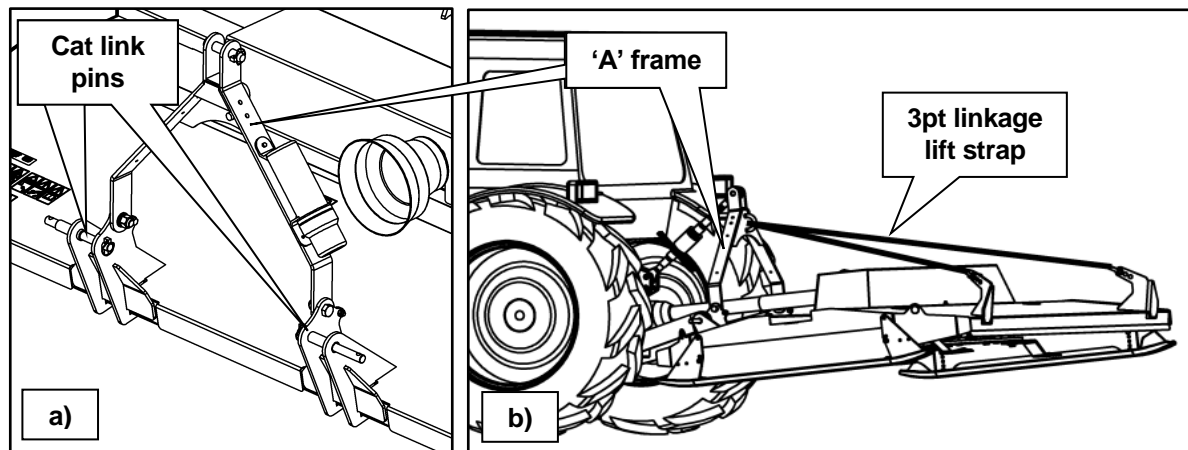

Figure 5.3

- 5.3.1.1 Remove or reposition any tractor drawbar so it does not foul on the PTO shaft.
- 5.3.1.2 Remove the two Cat I / Cat II link pins, and the Top Link Pin see Figure 5.3a. If necessary support the 'A' frame whilst doing this.
- 5.3.1.3 Reverse the tractor up to the machine and adjust the lift arm height to align with the pin holes. Turn off the tractor, apply the parking brake and remove the starter key.
- 5.3.1.4 Attach the lower lift arms to the machine using the Cat I/Cat II pins.
- 5.3.1.5 Adjust and attach the Left-Hand Lift Arm using the tractor Levelling Box if necessary
- 5.3.1.6 Refit the lynch pins.
- 5.3.1.7 Raise the 'A' frame and fit the top link. Adjust the length of the link to remove any slack and add tension to the transport strap, without lifting the rear of the machine off the ground.
- 5.3.1.8 Start the tractor and raise the machine on the lift arms until the gearbox PTO shaft of the machine and the tractor PTO are at their shortest distance apart.
- 5.3.1.9 Turn off the tractor, apply the parking brake and remove the starter key.
- 5.3.1.10 Adjust the tractor stabiliser chains (or bars) so there is no lateral movement when the machine is in the raised position.
- 5.3.1.11 Identify the end of the PTO containing the shear bolt and connect this end to the machine. Fasten the guard check chain securely.
- 5.3.1.12 Connect the other end of the shaft to the tractor, once again securing the guard 'check chain'.
- 5.3.1.13 With the PTO shaft correctly connected, raise the machine to a safe transport position. Ensure a clearance of at least 100mm between the underside of the shaft and the body of the machine whilst in the transport position.
- 5.3.1.14 Lock the 'lift-arm-stop' in this position.



CAUTION: Raising the tractor lift arms too high may cause damage to the PTO shaft if the tractor was to drive over any bumps and the machine was to bounce on the lift arms.

- 5.3.1.15 Check that there is no lateral movement on the machine when it is in the raised position; adjust the stabiliser chains/bars if required.
- 5.3.1.16 On the first occasion when the machine is fitted to a tractor the PTO shaft may need adjusting in length. Refer to section 5.4.1. below. Bear in mind that using the machine on another tractor later may necessitate further adjustments or the fitting of a new, longer shaft.



WARNING: Read all the safety instructions carefully before driving on the public road and always comply with the local law concerning lights, warning and safety signs. The driver and/or the owner of the machine have the responsibility of complying with the local Road Traffic Acts.

Always ensure tractor manoeuvrability is not adversely affected by any attached machinery; the steering axle of the tractor should be loaded with at least 20% of the tractor and cutting implement's combined dead weight. See Safety section.



DANGER: The carrying of passengers on the machine is strictly prohibited.

5.3.2 Setting the cutting height



WARNING: Before attempting to access the underside of the machine, ensure it is adequately and safely supported. Do not rely on the tractor's hydraulics. Use safety supports that are capable of supporting the machine mass indicated in Section 1.4 Machine general specification.

Undo the side skid attachment bolts and using the cut height decal reposition the side skids at the desired cut height, see Figure 5.4.



WARNING: Take care to ensure that both skids are set at the same height.

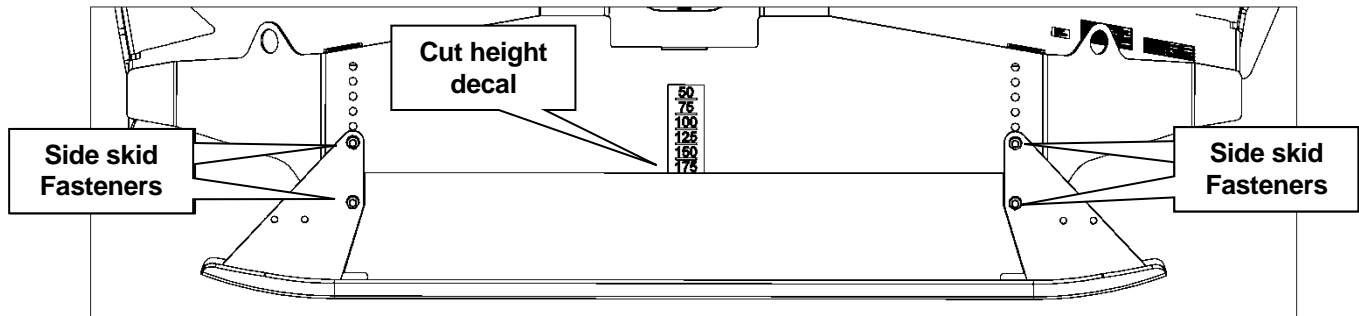

Figure 5.4

If your machine is equipped with folding wings or, decks mounted on deployment arms, make sure that each deck is level and parallel to the ground. Failure to 'set' the machine for level cutting will result in an uneven cut height.

5.4 PTO driveshaft installation

The PTO driveshaft attaches between the tractor and the machine gearbox to transfer the power required to the run and operate the machine – it is important to achieve the correct shaft length to avoid risk of it 'bottoming out' when raising or lowering the machine.

Due to many different makes and sizes of tractor to which mowers may be fitted, a nominal length PTO shaft is supplied with the machine. In some cases, the nominal PTO shaft supplied will be too long and will have to be shortened, see below.

IMPORTANT: The recommended minimum engagement of the PTO is 150mm in the working position. This measurement must be considered when shortening the PTO shaft. (See Figure 5.6)

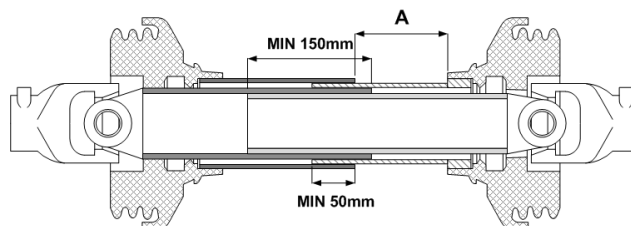

Figure 5.5

5.4.1 Shortening the PTO length

- 5.4.1.1 Both machinery and tractor must be parallel to one another.
- 5.4.1.2 Pre-assemble the PTO shaft and check that the drive tube overlap is not less than 150mm, see Figure 5.5 and Figure 5.6 a.
- 5.4.1.3 Check that the minimum overlap of the shaft guards is not less than 75mm, see Figure 5.5.
- 5.4.1.4 If the overall PTO length is likely to reduce during operation then ensure that at its minimum there is at least 40mm movement left between the guards, see dimension 'A' in Figure 5.5.
- 5.4.1.5 If the PTO needs to be shortened, cut both tubes as both halves must be shortened equally, see Figure 5.6 b.
- 5.4.1.6 Remove burrs with a file and clean any residual cutting debris from the tubes.
- 5.4.1.7 Before fitting the PTO shaft to the tractor, grease the sliding drive shafts and bearing units.
- 5.4.1.8 Fit the PTO to the tractor ensuring that the locking peg and collar on the spline-coupling is fully engaged.
- 5.4.1.9 Attach the PTO guard check chains to the tractor and to the machine to prevent guard rotation.

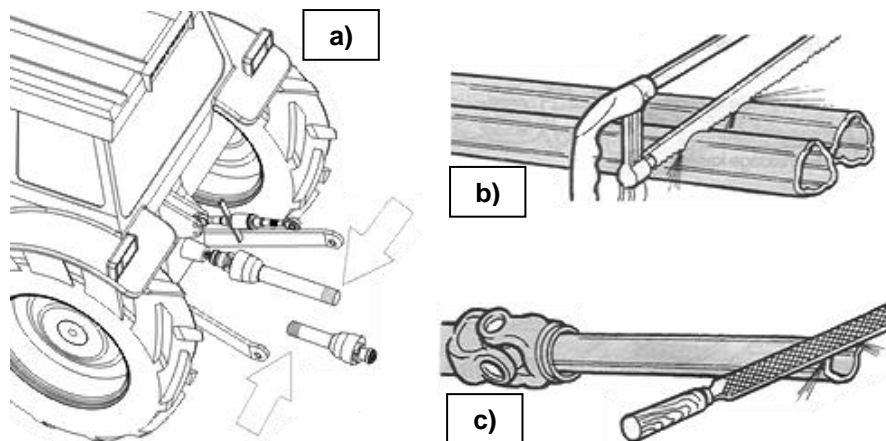

Figure 5.6

5.4.2 PTO Maintenance

To increase the working life of the PTO shaft it should be periodically checked, cleaned and lubricated – refer to the manufacturer's manual provided with the shaft for further details on this subject.

5.5 Installation checks

After the machine has been attached to the tractor for the first time, it should be tested to ensure it operates correctly, before putting it to work.

5.5.1 Initial run-up

Use the following procedure when running the machine for the first time.

- 5.5.1.1 Lower the machine so the skids are resting on the ground, and the machine is level.
- 5.5.1.2 With the tractor at low revs, gently engage the PTO until the machine is running.
- 5.5.1.3 Carefully increase the PTO speed to 540 rpm.
- 5.5.1.4 Check that the machine runs smoothly and without vibration.
- 5.5.1.5 Raise the machine to top of lift arm travel.
- 5.5.1.6 Check again that the machine runs smoothly and without vibration.
- 5.5.1.7 Lower the machine to ground level again.
- 5.5.1.8 Gently reduce the tractor revs to idle and disengage the PTO.
- 5.5.1.9 Apply the parking brake and stop the tractor.

If any faults are identified, refer to 'Trouble shooting' section. If a solution is still not found, consult your local Spearhead dealer for assistance.

5.5.2 Checking Head float

All Spearhead machines have head float fitted as standard. Head float allows the cutting unit to pitch fore - aft around the lower link pins, smoothing out undulating ground. To check the head float operation, adjust the top link to slacken off the transport strap and allow approximately 50.0 mm of play when the machine is lowered onto the skids on a level surface, see Figure 5.7.

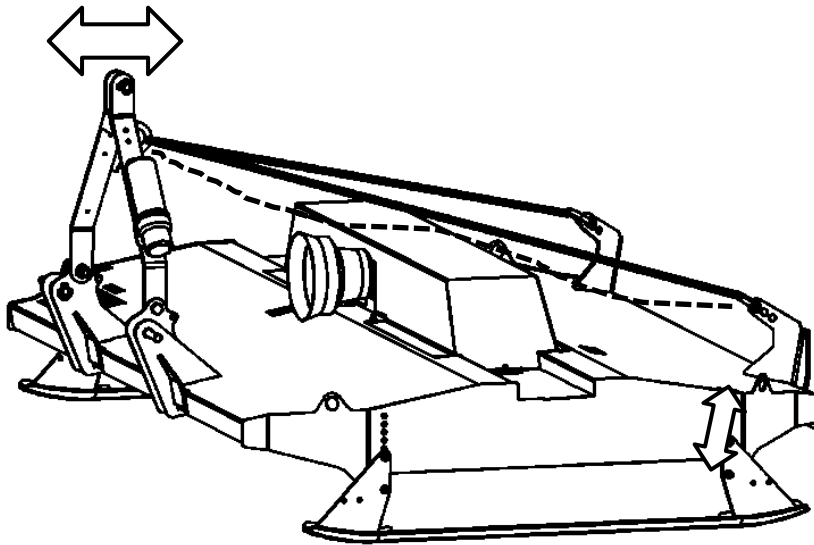

Figure 5.7

6 General operation

6.1 Operator training

These notes are produced for guidance and are intended to help the operator obtain the best results from the machine, with the minimum of trouble and downtime. The operator should read the following pages carefully and be familiar with the contents before commencing work. A familiar knowledge of the operator instruction manual forms an essential part of the training record for a competent user.

The Spearhead Agricut range is primarily designed for the topping of grass pasture land after grazing, or for thistle and weed control on agricultural land and must not be used for any other purpose. The Spearhead Agricut range is not designed for grass mowing, set-aside cutting or brush/woodland clearance. Use in any other way than stipulated above is considered as contrary to the intended use. Compliance with, and strict adherence to, the conditions of operation, service, and repair, as specified in this manual is also considered as the intended use.

This machine should be operated, serviced, and repaired only by persons who are familiar with its particular characteristics and who are acquainted with the relevant safety procedures. Accident prevention regulations, all other generally recognised regulations on safety and occupational medicine, and all road traffic regulations must be observed at all times.

This operator's manual should be regarded as part of the machine. Suppliers of both new and second-hand machines are advised to retain documentary evidence that this manual was provided with the machine. Record the serial number and product number inside the front cover of this manual. These numbers can be found on the machine serial number plate (See Figure 6.1) which is located on the front right-hand face of the cowl (See separate Parts book). Always quote these numbers in any correspondence with a dealer.

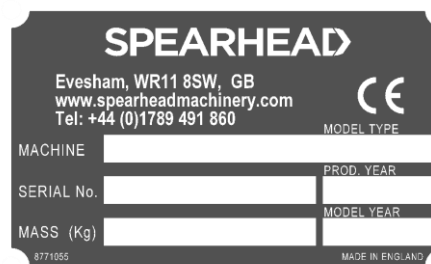

Figure 6.1

The parts manual supplied with the machine is specific to the construction of the machine. It will already contain the machine serial number on each page. Upon delivery always confirm that the parts book serial number matches the machine serial number.

6.2 Machine inspection records

Section 6.4 below offers format for an inspection record sheet which can be used when inspecting a Spearhead flail mower or hedge cutter. This form can be photocopied from the manual. When completed and filed in a machine log these records together with the operator training records and service records can accumulate to a useful machine ownership record.

Machines should be checked pre-delivery, post installation and prior to each work shift. Inspection should be carried out preferably by the operator or a suitably qualified responsible person.

The tractor engine must be switched off with the key removed. The cutting head must be positioned flat on the ground or suitably rested on blocks either side of the cutting head. All hydraulics must be 'rested' and residual pressure removed from any of the rams. Steam cleaning the machine will help with this inspection.

6.3 In the maintenance toolbox (Not supplied)

The user's own maintenance toolbox should contain a selection of replacement blades, blade bolts and blade bushes and washers matching those fitted to the blade bar prior to work. The toolbox should also contain the appropriate spanners to make the changes to blades and to remove guarding for inspection if necessary.

6.4 Operator use and adjustment



WARNING! Before use ensure that all operators have read and thoroughly understood all the safety procedures. For further information refer to the relevant sections of this manual.

6.4.1 Machine Settings and Adjustments



WARNING! Before working on any piece of attached machinery, ensure that the tractor engine is turned off and the starter key removed to prevent anyone else from starting the tractor while it is being worked on.



WARNING! Always park on a suitable firm, level surface with the parking brake applied, and ensure the machine has come to a complete stop before commencing work.



WARNING! Before attempting to access the underside of the machine, ensure it is adequately and safely supported. Do not rely on the tractor's hydraulics. Use safety supports that are capable of supporting the machine mass indicated in Section 1.4 Machine general specification.

6.4.2 Setting the cutting height using skids

The cutting height of the pasture topper can be adjusted to cut at heights from 50mm to 175mm. This is achieved by moving the bolt-on skids at each side of the machine.



WARNING! Use assistance when removing the skids. They are heavy and may cause injury.

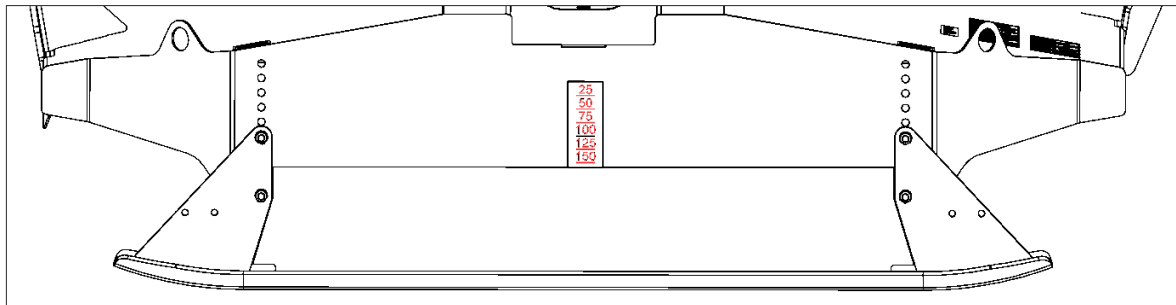

Figure 6.2

To adjust the cutting height:

- 6.4.2.1 Raise the machine on the tractor lift arms and support it on safety supports.
- 6.4.2.2 Remove the nuts, bolts and washers securing the skid to the machine.
- 6.4.2.3 Reposition the skid to the new desired position. Use the cutting height decals on the side of the machine. See Figure 6.2 as a guide.
- 6.4.2.4 Fit and tighten all nuts and bolts securely, see 'Torque Settings', page 43.
- 6.4.2.5 Repeat the process for the other skid, ensuring that both skids are at the same height setting.
- 6.4.2.6 Raise the machine on the lift arms and remove the safety supports.

Re-try the machine and re-adjust the skid height if the cutting height is still not acceptable.

WARNING! When raising the mower to transport height ensure there is clearance between the mower and the driveline. **DAMAGE CAN BE CAUSED IF THE DECK CONTACTS THE DRIVELINE.**



WARNING! Avoid injury. Stop the tractor engine, remove ignition key and allow blades to stop rotating before making adjustments.

IMPORTANT Avoid very low cutting heights; striking the ground with the blades can send damaging shock loads into the gearboxes and drive system which will also cause premature blade wear.

6.4.3 Shear bolt protection (If fitted)

The P.T.O. shaft is fitted with a shear bolt overload protection to prevent damage to the machine if an obstacle is encountered during operation. The shear bolt is located at the machine end of the PTO shaft. The following procedure should be followed when replacing or inspecting the shear bolt.

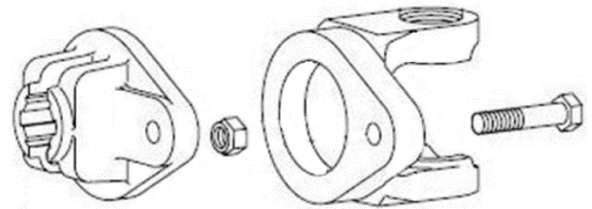

Figure 6.3

- 6.4.3.1 Disengage the PTO.
- 6.4.3.2 Raise the machine on the lift arms and move to an area with a firm, level surface.
- 6.4.3.3 Lower the machine and stop the tractor.
- 6.4.3.4 Apply the parking brake and remove the starter key.
- 6.4.3.5 Release the guard restraining chains and disconnect the PTO shaft from the tractor end first, and then from the machine. This will give access to the shear bolt for inspection and replacement.
- 6.4.3.6 Inspect the machine, shaft and ground for possible causes of failure. Check that the blade rotates freely and does not foul on the body.
- 6.4.3.7 Remove any bolt remains from the universal joint and replace the shear bolt with the correct grade of new bolt. Four spare shear bolts and nuts are supplied with each new machine. These are stored on the 'A' frame or the headstock gearbox mounting plate. Ensure the bolt is correctly tightened, see Figure 6.3.



CAUTION: Only use the size and grade of shear bolt as supplied by Spearhead Machinery. For further information refer to the Serial number specific parts book supplied with your machine.

- 6.4.3.8 Connect the shaft to the machine and then the tractor and attach the guard check chains.
- 6.4.3.9 Re-start the machine as described in 'Running the Machine for the First Time', see section 6.4.8, and check that it operates correctly.

6.4.4 Setting slip clutch PTO (Option - if fitted)

It is important that the clutches slip when an obstacle or load heavier than the clutch setting is encountered. Therefore, if the machine sits outside longer than 30 days and is exposed to rain and/or humid air, it is important to make sure that the clutch lining plates are not rusted/corroded together. Before using the machine, use the following procedure to make sure the clutch will slip and give the overload protection required.

- 6.4.4.1 Measure the spring lengths. These should be 33.2mm on a 540rpm machine, and 33.0mm on a 1000 rpm machine. Spring compression and the clutch friction material determines the power transferred through the clutch.
- 6.4.4.2 Loosen the nuts on all springs, see
- 6.4.4.3 Figure 6.4 A, just until the springs can freely rotate, yet remain secure on bolts.
- 6.4.4.4 Mark the outer edge of the friction plates as shown in
- 6.4.4.5 Figure 6.4 B.
- 6.4.4.6 Set the PTO speed to that detailed in Section 1.4 'Machine general specification'.
- 6.4.4.7 Start the tractor engine and engage the PTO (for approximately one second duration) and then quickly disengage it. The friction lining plates should break loose.
- 6.4.4.8 Turn the tractor off, engage parking brake and remove and pocket the key.

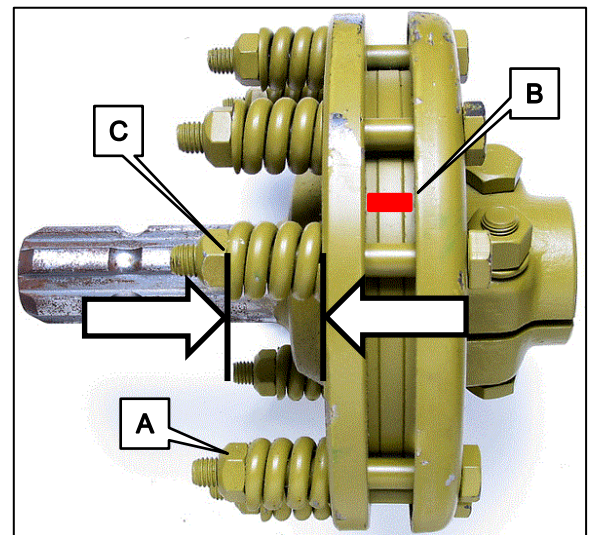

Figure 6.4

- 6.4.4.9 Inspect the previous marking on the friction plates. The mark should now be out of alignment, showing that the slip clutches have operated. If not, completely dismantle and clean all mating surfaces.
- 6.4.4.10 If the above power test is successful and the marks are not aligned, then tighten the nuts on the springs to their original position (see
- 6.4.4.11 Figure 6.4 C) and replace all guarding.

6.4.5 Transportation to work site

With the PTO shaft correctly connected, raise the machine to a safe transport position. Lock the lift arm stop in this position. Check that there is no lateral movement on the machine when it is in the raised position. Adjust the tractor stabiliser chains (or bars) if required.



CAUTION: Raising the tractor lift arms too high may cause damage to the P.T.O. shaft if the tractor was to drive over any bumps and the machine was to bounce on the lift arms.

Before Driving on public roads, the machine should be raised on the lift arms to the transport position and the following checks made;

- 6.4.5.1 Is the machine correctly coupled with all securing pins and clips in position?
- 6.4.5.2 Does the machine have any loose or unsecured parts?
- 6.4.5.3 Does any part of the machine protrude beyond the width of the tractor?
- 6.4.5.4 Are the tractor's lights, indicators and beacon working correctly and are they all clearly visible?
- 6.4.5.5 Are there any bystanders or children in the immediate area? If so, ask them to clear the area before moving off.

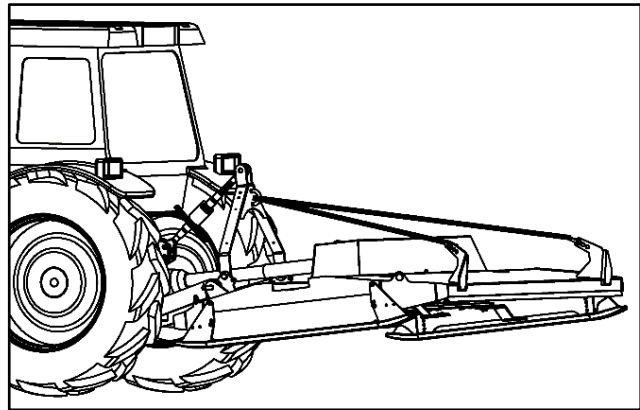

Figure 6.5

6.4.6 Driving on Public Roads



DANGER! Carrying passengers on the machine is strictly prohibited.



WARNING! Read all the safety instructions carefully before driving on the public road. This will ensure that dangerous situations and accidents are avoided. Lack of information can cause accidents.

Comply with the local law concerning lights, warning and safety signs. The driver and/or the owner of the machine has the responsibility of complying with the local Road Traffic Acts.

The tractor's manoeuvrability should not be adversely affected. The steering axle of the tractor should be loaded with at least 20% of the tractor's dead weight.

Before driving off and whilst driving on public highways continue to monitor the following points;

- 6.4.6.1 Check the area around the machine before you start.
- 6.4.6.2 Be aware of children in the danger area of the machine.
- 6.4.6.3 Do not exceed 30 km/h.
- 6.4.6.4 Adjust the speed according to the road conditions.
- 6.4.6.5 Avoid sudden sideways movement with the machine attached.
- 6.4.6.6 Make sure that steering and braking ability are not compromised.
- 6.4.6.7 Take care when turning corners, as the machine may swing out into the path of other road users.

6.4.7 Cutting deployment and retraction

For machines where the cutting height has already been set, then to lower the machine from the transport position into the working position, first ensure that the machine and the PTO shaft have been correctly connected to the tractor. (For further information refer to machine preparation section.)

Visually confirm that the chosen location for deployment or retraction of the arm has plenty of clear space for the manoeuvre.

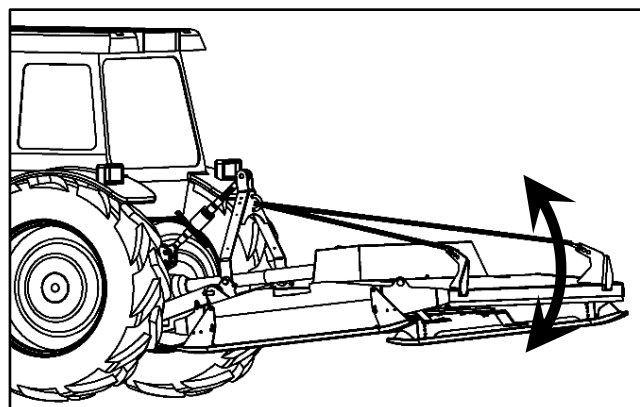

Figure 6.6

Lower the machine so that the skids are on the ground, apply tractor hand brake, and turn off engine.

If possible set the lift arms to float to allow the skids to follow side to side undulations in the ground. If necessary, adjust the top link to slacken the transport strap to allow for 50mm of play. This will allow the skids to follow fore / aft undulations in the ground.

To move the machine from the working position to the transport position is the reverse of the above procedure. Before moving off in transport ensure that the lift arm float is disengaged and that the lift arms are locked off.



DANGER! At no time should the machine be moved from working to transport position whilst the PTO is engaged, or the machine is running down. Ensure the rotors are at a complete standstill before moving.



WARNING! Serious damage to the driveline will result from deployment or retraction if the PTO is engaged, or the machine is running down.

6.4.8 Start-up.

Ensure that the machine and the PTO shaft have been correctly connected to the tractor. Refer to machine preparation section.

Ensure that the machine is positioned correctly in the working position. Refer to sections 6.4.7.

Visually confirm that there is plenty of space in the chosen location for run-up and checking of the machine.

Ensure there are no children, bystanders or animals in the immediate area when the machine is run for the first time.

6.4.9 General use – Grass cutting.

Having transported the machine to the required work location, follow the guidelines below;

- 6.4.9.1 Lower the machine fully so that both skids are firmly on the ground.
- 6.4.9.2 Lift the machine so it clears the ground by approximately 100mm, gently engage the P.T.O. and run at tick-over speed.
- 6.4.9.3 Lower the machine to the ground and increase the P.T.O. speed to 540 rpm.
- 6.4.9.4 Select a forward speed that is suitable for the ground conditions and the type of material to be cut.
- 6.4.9.5 Check the machine is floating correctly, see sections 6.4.7.

NOTE: When turning at headlands, lift the machine so the skids just clear the ground. This will prevent damage to the hitch and reduce field damage in wet conditions.

If the stubble height is not correct, adjust the skid height accordingly. Refer to section 6.4.2.

6.4.10 Stopping the Machine

When stopping the machine, use the following procedure:

- 6.4.10.1 Reduce forward speed and bring the tractor to a halt.
- 6.4.10.2 Keep the machine lowered onto the ground.
- 6.4.10.3 Reduce engine revs to idle speed and disengage the PTO.
- 6.4.10.4 When the rotor has stopped turning, raise the machine, and if applicable move the swing arm to the transport position.

7 Removal, Storage and Disposal

Before removing the machine from the tractor, a thorough check of the machine should be made.

7.1 Preparation for Storage

At the end of the season the machine should be readied for winter storage. Carry out the following:

- 7.1.1.1 Clean the machine thoroughly.
- 7.1.1.2 Always check that the machine's safety equipment is not worn or damaged.
- 7.1.1.3 The PTO shaft should be cleaned, oiled and stored somewhere dry so as to avoid damage or corrosion.
- 7.1.1.4 Repair any damaged components.
- 7.1.1.5 Replace any defective components.
- 7.1.1.6 Check and tighten all bolts.
- 7.1.1.7 Lubricate the machine following the lubrication program.
- 7.1.1.8 Repair any paint damage and replace any missing decals.
- 7.1.1.9 Smear all unpainted metal parts with protective grease.
- 7.1.1.10 Store the machine in a well-ventilated building.

7.1.2 Cleaning the Machine



WARNING! Always pay attention to the area and environment when carrying out any cleaning work, this will reduce the risk of injury to you and others.

7.1.2.1 Before cleaning:

- Check the area around the machine for hazardous or loose material.
- Apply the parking brake and stop the tractor.
- Remove the starter key from the tractor.
- Disconnect the P.T.O. shaft.

7.1.2.2 Personal Protective Equipment (PPE)

Protect your body and face when cleaning the machine. Wear the correct protective gear for body and face when cleaning the machine. This will protect your body and face from dirt and oil splashes. Insufficient protection of body and face can lead to severe skin and eye injuries.

7.1.2.3 Cleaning Agents



CAUTION: Some cleaning products contain chemicals that are hazardous to the environment. Always take precautions to prevent spillage of fluids while cleaning.



CAUTION: Only use pH neutral cleaning agents when cleaning the machine. pH neutral cleaning agents give your machine maximum protection. Cleaning agents with either high or low pH value can be corrosive on plastic, rubber and varnished surfaces.



CAUTION: High pressure cleaning equipment may be used to clean. However, the area around the bearings should be cleaned using gentle squirts of water.

7.1.2.4 After Cleaning: Let the remaining water run off for about one hour.

7.2 Parking



DANGER! The machine must be correctly secured when parked in storage. A correctly secured machine prevents serious accidents. If the machine is not properly secured when parked it can result in serious injuries or death.

The following guidelines should be used when parking-up the machine at the end of the season;

- 7.2.1.1 The machine is placed on a firm and level surface.
- 7.2.1.2 The tractor must not roll after being disconnected.
- 7.2.1.3 The tractor has stopped, the parking brake is applied, and the starter key is removed.
- 7.2.1.4 The machine has come to a complete stop.
- 7.2.1.5 Children are never allowed to play close to the machine.

7.3 Removal

Disconnection from the tractor is the reverse of attachment. Refer to the 'Installation' section.



WARNING! There is an increased risk of injury when disconnecting the machine from the tractor. Before disconnecting the machine, make sure that:

- The machine is placed upon a firm and level surface.
- The tractor cannot roll after being disconnected.
- The tractor has stopped, the parking brake is applied, and the starter key is removed.
- The machine has come to a complete stop before commencing work.
- Children are never allowed to play close to the machine.

7.4 Disposal

When Spearhead equipment reaches the end of its economic working life it should be disposed of responsibly, either through an approved recycling centre or by compliance with all applicable regulations in force in its final destination territory.

In most instances Spearhead machines can be broken into its constituent parts with the use of basic workshop equipment. Figure 7.1 contains a typical list of constituent materials, together with disposal guidelines.

When undertaking a machine breakdown take care to ensure heavy parts are adequately supported at all times to avoid injury and take containment precautions to retain control of liquids to avoid environmental contamination.

It is the owner's responsibility to ensure the machine is disposed of in accordance with all applicable regulations.

Material	Typically found in;	Disposal guideline
Steel	Structural components, fixed guards, fasteners and driveline	Can be dismantled and recycled. Take care when handling heavy and/or sharp objects
Aluminium	Pump and gearbox housings, serial number plates	Can be dismantled and recycled. Take care when handling heavy and/or sharp objects. Take appropriate actions for oil contaminated products
Copper	Wiring, electrical components	Can be recycled using appropriate recovery procedures.
Hydraulic oil	Tank, hydraulic components	Dispose of in accordance with all applicable regulations
Rubber	Hoses, flexible guards, seals, 'O' rings	Dispose of in accordance with all applicable regulations
Plastics	Clips, caps, cable ties, decals, filter housings, document holders, bushes, electrical components, plugs, connectors, wire insulation	Dispose of in accordance with all applicable regulations
Filter element	Filter housings	Dispose of in accordance with all applicable regulations
Cork / paper	Gaskets	Dispose of in accordance with all applicable regulations
Oil	Gearboxes	All oil must be emptied from the machine. The oil that has been drained from the machine must be processed in accordance with current regulations

Figure 7.1

8 Maintenance

8.1 Regular Maintenance chart

Regular maintenance carried out at the intervals specified in the maintenance chart will ensure that the machine operates correctly and safely and minimise operational down time.

Component type and maintenance guideline	Maintenance intervals					
	1 st hour	After 10 hours	Weekly	Every 2 weeks	Monthly	Annually
P.T.O. Shaft						
Refer to the supplied P.T.O. shaft manual for guidance on lubrication.						•
Gearboxes						
Check gearbox mounting bolts, see section 8.5.1.	•		•			•
Check gearbox oil level, see section 8.5.2.		•		•		•
Change gearbox oil, see section 8.53.						•
Blade carrier						
Check mounting bolts, see section 8.62.	•		•			•
Blades						
Check for damage.		•	•			•
Check bushes for wear, see section 8.64.		•			•	•
Other						
Check all other fasteners.					•	•

8.2 Maintenance Safety



WARNING! Before attempting to access the underside of the machine, ensure it is adequately and safely supported. Do not rely on the tractor's hydraulics. Use safety supports that are capable of supporting the machine mass indicated in Section 1.4 Machine general specification.



WARNING! Repair and maintenance work should only be performed if you have the necessary professional knowledge, the proper tools and comply with the following guidance:

- Always park on a suitable firm, level surface with the parking brake applied.
- Ensure the tractor engine is turned off and the starter key removed to prevent anyone else from starting the tractor while it is being worked on.
- Disconnect the PTO shaft.
- Never work between the tractor and the machine if the machine has not been secured.
- Always use original spare parts on the machine.

8.3 Lubricating Oil Precautions



WARNING! Avoid excessive skin contact with used oil. Used oil contains potentially harmful contaminants which may cause skin cancer or other serious skin disorders.

- 8.3.1.1 Avoid excessive skin contact with used lubricating oils and always adhere to the health protection precautions.
- 8.3.1.2 Avoid prolonged and repeated contact with oils, particularly used engine oils.
- 8.3.1.3 Wear protective clothing, including impervious gloves where practicable.
- 8.3.1.4 Avoid contaminating clothes with oil (particularly those next to the skin). Overalls must be cleaned regularly. Discard heavily soiled clothing and oil impregnated footwear.
- 8.3.1.5 First aid treatment should be obtained immediately for open cuts and wounds.
- 8.3.1.6 Apply barrier creams before each work period, to help prevent lubricating oil from contaminating the skin.
- 8.3.1.7 Use moisturisers after cleaning; preparations containing lanolin help replace the skin's natural oils which have been removed.
- 8.3.1.8 If skin disorders develop, obtain medical advice without delay.
- 8.3.1.9 If there is a risk of eye contamination wear eye protection (e.g. goggles or a face shield). Eye wash facilities should be provided in close vicinity of the work area.

NOTE: Used oil must be collected and be delivered to a disposal company, where the oil will be processed according to the governing regulations.

8.4 Power Take Off (P.T.O.) Shaft

To increase the working life of the PTO shaft it should be periodically checked, cleaned and lubricated. Refer to the manufacturer's instructions, (supplied with the shaft) to adjust or service the PTO shaft.

8.4.1 Seasonal slip clutch maintenance. (If fitted)

It is important that the clutches slip when an obstacle or load heavier than the clutch setting is encountered. Therefore, if the machine sits outside longer than 30 days and is exposed to rain and/or humid air, it is important to make sure that the clutch lining plates are not rusted/corroded together. Before using the machine, use the following procedure to make sure the clutch will slip and give the overload protection required.

- 8.4.1.1 Measure the spring lengths. These should be 33.2mm on a 540rpm machine, and 33.0mm on a 1000 rpm machine. Spring compression and the clutch friction material determines the power transferred through the clutch.
- 8.4.1.2 Loosen the nuts on all springs, see Figure 8.1 (A), just until the springs can freely rotate, yet remain secure on bolts.
- 8.4.1.3 Mark the outer edge of the friction plates as shown in Figure 8.1 (B).
- 8.4.1.4 Set the PTO speed to that detailed in Section 1.4 'Machine general specification'.
- 8.4.1.5 Start the tractor engine and engage the PTO (for approximately one second duration) and then quickly disengage it. The friction lining plates should break loose.
- 8.4.1.6 Turn the tractor off, engage parking brake and remove and pocket the key.

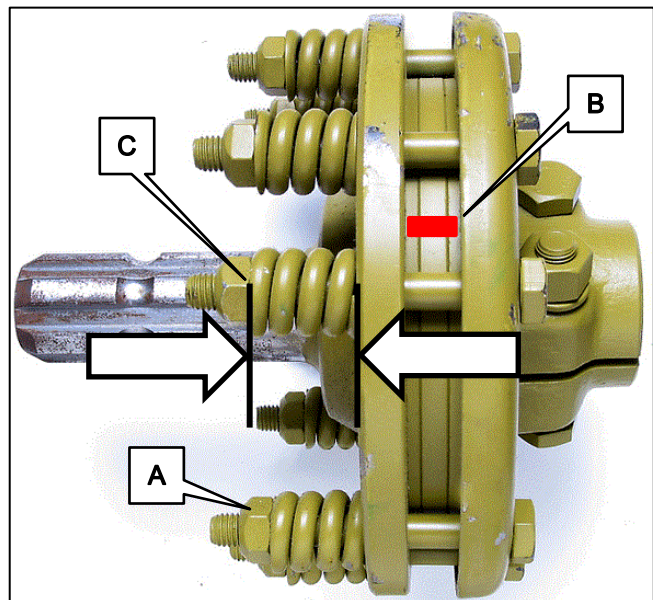

Figure 8.1

- 8.4.1.7 Inspect the previous marking on the friction plates. The mark should now be out of alignment, showing that the slip clutches have operated. If not, completely dismantle and clean all mating surfaces.
- 8.4.1.8 If the above power test is successful and the marks are not aligned, then tighten the nuts on the springs to their original position, see Figure 8.1 (C), and replace all guarding.

8.5 Driveline

8.5.1 Gearbox Mountings Bolts

Check the gearbox mounting nuts and bolts at the intervals stated in the regular maintenance chart, see section 0 and retighten if required. Locations of the mounting nuts and bolts are indicated in Figure 8.2.

8.5.2 Oil Level

Check the gearbox oil level at the intervals stated in the regular maintenance chart. (See section 8.1); ensure the machine is lowered to the ground and located on a firm level site to perform this task.

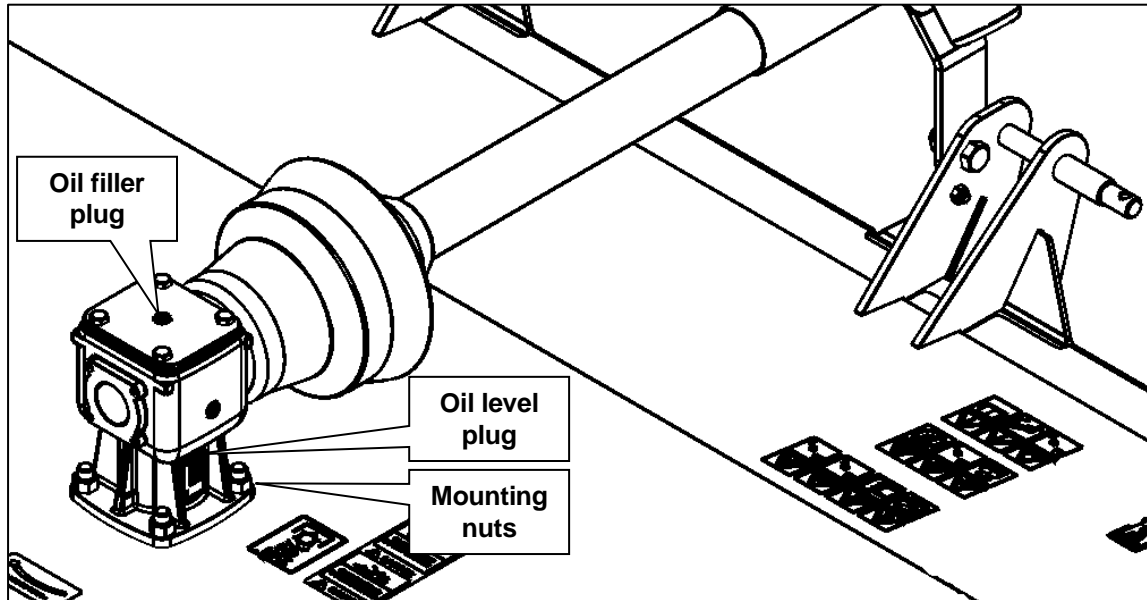

Figure 8.2

Checking the oil level in the gearbox is by removal of the oil level plug in Figure 8.2, the level is correct when the oil is up to the bottom of the side level plug orifice. If the gearbox requires 'topping up' add oil via the top filler plug in Figure 8.2 until it starts to seep from the side level plug orifice; replace both plugs securely to complete the task.

Gearbox oil levels must be checked on a fortnightly basis during the season and the oil completely drained and replaced annually.

8.5.3 Draining & Refilling

To drain oil from the gearbox it is necessary to remove the gearbox from the machine. Remove both the filler and the level plugs and invert the gearbox over a suitable container to allow the oil to drain completely. Replace the gearbox on the machine before refilling to the level stated above. Refer to recommended lubricants page for gearbox oil specifications.

8.6 Blade bar



WARNING! Ensure that the machine is safely supported using suitable lifting and support equipment before attempting to work beneath a machine – never use or rely on the tractor's hydraulic system to support the machine

8.6.1 Blade bar Maintenance

Check the rotor hub for slack. Some settlement may occur after the first hours of working. Re-tighten the castle nut one quarter of a turn at a time, and back off until the split pin can be fitted. Repeat until the slackness is removed. Check the blade carrier mounting bolts for tightness, see Figure 8.5.

8.6.2 Removal and replacement of Blade carrier assembly

Lift and support the machine on safety supports. With assistance, support the blade carrier assembly, remove the split pin (K) and rotor castle nut (J) in Figure 8.4 and remove the whole blade carrier assembly from the splined gearbox output shaft through (B), see Figure 8.3.

Replacement is the reverse of the removal procedure above. Tighten the mounting bolts and castle nut according to torque settings, see Figure 8.5.

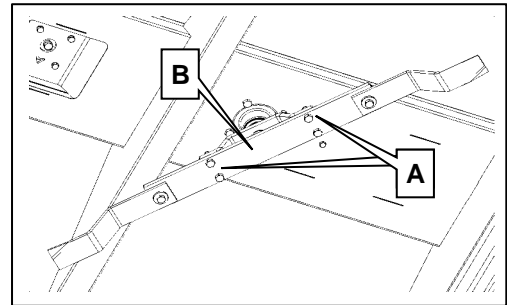

Figure 8.3



WARNING! Ensure that the opposing blade carriers and blades are at 90degree to each other after any maintenance that requires removing or replacing the gearboxes.

8.6.3 Blade bar removal

If necessary, the blade bar (G) in Figure 8.4 may be removed and replaced without upsetting the driveline timing. Undo four fasteners (A) in Figure 8.3. The blade bar with blades attached can be removed.

8.6.4 Blades and blade bushes maintenance

The cutting blades are mounted in bushes and are free-swinging to reduce shock load and damage to the transmission. Blades and blade bushes should be inspected for wear/damage the intervals stated in the regular maintenance chart, see section 8.1.

Replace blades that are bent, excessively nicked, damaged, or when they are worn beyond the shape of their original profile. Always replace blades immediately when their level of wear or damage causes rotor vibration; continued use of the machine in this condition could cause damage to gearbox and/or drive components. Blades must always be replaced in opposing pairs to retain rotor balance. Replace bushes and blade fixings immediately should excessive signs of wear or damage be detected.

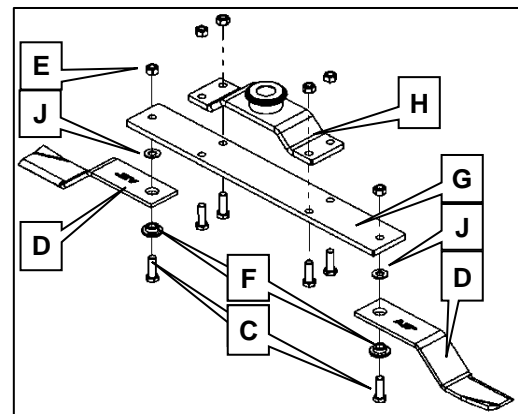

Figure 8.4

NOTE: On twin rotor machines the cutting blades on the left and right blade carriers are not interchangeable due to their different rotation direction.

8.6.5 Blade & Blade bush removal and replacement

To Remove: Unfasten blade bolt (C), locknut (E), flat washer (J) in Figure 8.4 and discard. Dismantle the blade (D) and blade bush (F).

To replace: Fit the blade and/or the bush and reassemble to the blade bar or carrier assembly with a new locknut (E), bolt (C) and flat washer (J). Tighten the blade bolt (C) and locknut (E) to torque value in Figure 8.5



WARNING! Blades must always be replaced in opposing pairs to retain rotor balance.

NOTE: On Twin Rotor machines the cutting blades on the left and right blade carriers are not interchangeable.

8.7 Fastener Torque Guidelines

8.7.1 Specific Torque Settings



CAUTION: This table refers to bolts that **MUST** be tightened to the figure shown. Where a specific torque setting is given it should be used instead of the information shown in the Figure 8.6.

Specific Torque settings for Agricut models (Nm)	
Fastener	Agricut 180 in-line
PTO Shaft Shear bolt	26
Outer Gearbox Mounting Bolts	N/A
Centre Gearbox Mounting Bolts	225
Flexible Coupling Bolts	N/A
Blade Carrier Bolts	225
Cutting Blade Bolts	315
Rotor Hub Castle Nut	M24x2 see section 8.6.1

Figure 8.5

8.7.2 General Torque Settings



CAUTION: This table refers to bolts without a torque setting specified above. Please check Figure 8.5 first. Where a specific torque setting is given it should be used instead of the information below.

The figures shown are for the torque moment for bolts of normal metric thread quality 8.8 black and/or galvanised and ungreased when tightened on a smooth surface or a plain washer.

Thread Diameter (mm)	Nm + 10% / - 0
5	6
6	10
8	26
10	52
12	90
14	144
16	225
20	436
22	594

Figure 8.6

8.7.3 Converting chart between Measuring Systems

Basic Unit	SI Metric Unit	Conversion Number
Length	1 meter (m)	39.4 inches (in), 3.3 feet (ft), 1.1 yard (yd)
Area	1m ²	10.8 ft ² , 1.2 yd ²
Volume	1 litre, 1dm ³	1.76 pints (pt), 0.22 gallons (gall) (Imp), 0.26 gall (US)
Speed	1 m/s	3.6 km/h, 2.24 mph
Force	1 Newton (N)	0.22 lbf
Power	1 KW	1.34 hp, 860 kcal/h, 737 ft lbs/s
Mass	1 kg	35 ounces (oz), 2.2 pounds (lb), 0.0197 hundredweight (cwt)
Moment	1 Nm	8.8 lbf in, 0.74 lbf ft
Pressure	1 kPa	0.01 atmospheres, 0.14 lbf/in ²
Rotation speed	Min-1	r.p.m

Figure 8.7

9 Trouble shooting

Trouble shooting – Rotary mower issues			
	Symptom	Possible cause	Remedy
9.1	Machine vibration.	Missing Blades	Replace opposite blades as pairs
		Broken Blades	Replace opposite blades as pairs
		Wrong PTO speed	Check that a 540rpm machine is not run at 1000rpm
9.2	Blades touching one another.	Blades are out of timing	Re index the blades but check that there are no teeth failures within the gearbox
9.3	PTO shaft not transmitting power.	Slip clutch if fitted slipping	Re set the clutches as per the instruction book
		Shear bolt failed if fitted	Replace the shear bolt after checking that the correct grade is being used
			Check that the shear surfaces are still square and not rounded. Check that shear bolts are tight.
9.4	Uneven cutting height.	Machine not set level with ground	Stop the machine and set the machine as shown in the instruction book
9.5	Machine not cutting.	Blades not fitted to suit rotation	Check the blade rotation suits the cutting edge of the blade
9.6	Leaking gearbox.	Oil level too high	Reduce the oil level to the level plug
		Wrong oil grade	Check instruction book for the correct grade
		Faulty breather	Replace the breather
		Wrong breather alignment with crown wheel	Rotate the cover with the breather so the breather is off set to the crown wheel
9.7	Rapid blade wear.	Cutting too low	Set the machine for sensible cutting height
9.8	Blades hitting the machine sides.	Worn pivot collars and bolts	Replace any worn collars and or bolts. Remember to replace lock nuts at the same time.
9.9	Breakout system if fitted not working.	Machine will not break out	If hydraulic check that the tractor valve is in "float" whilst cutting.
9.10	Machine will not "float".	Poor setting of any balance spring(s)	Reset any balance spring as per the instruction book
9.11	Wings, if fitted, will not drop or do so reluctantly.	Twisted wing PTO shafts	Reset "frozen" wing PTO shafts and replace the PTO shaft drive tube
9.12	Loss of drive to one axle.	Drive shaft or gearbox tooth failure	Replace damage parts and check slip clutches and or shear bolt grade/size

10 Warranty Information

Despite our best efforts to ensure that your new machine is delivered on time, works correctly and is defect free, some defects do infrequently slip through our quality net. Equally, when in use, accidents happen and damage is caused. To cover these situations Spearhead Machinery operates a Warranty policy.

10.1 Warranty policy

10.1.1 Warranty registration

All machines must be registered, by the selling dealer with Spearhead Machinery, before delivery to the end user. On receipt of the goods it is the buyer's responsibility to check that the Verification of Warranty Registration in the Operator's Manual has been completed by the selling dealer.

10.1.2 Limited warranties

All machines supplied by Spearhead Machinery are warranted to be free from defects in material and workmanship from the date of sale to the original purchaser for a period of 12 months, unless a different period is specified.

All spare parts supplied by Spearhead Machinery and purchased by the end user are warranted to be free from defects in material and workmanship from the date of sale to the original purchaser for a period of 6 months. All parts warranty claims must be supported by a copy of the failed part invoice to the end user. We cannot consider claims for which sales invoices are not available.

The warranty offered by Spearhead Machinery is limited to the making good by repair or replacement for the purchaser any part or parts found, upon examination at its factory, to be defective under normal use and service due to defects in material or workmanship. Returned parts must be complete and unexamined. Pack the component(s) carefully so that any transit damage is avoided. All ports on hydraulic items should be drained of oil and securely plugged to prevent seepage and foreign body ingress. Certain other components, electrical items for example, may require particular care when packing to avoid damage in transit.

This warranty does not extend to any product from which Spearhead Machinery's serial number plate has been removed or altered.

This warranty does not apply to any part of the goods, which has been subjected to improper or abnormal use, negligence, alteration, modification, fitment of non-genuine parts, accident damage, or damage resulting from contact with overhead power lines, damage caused by foreign objects (e.g. stones, iron, material other than vegetation), failure due to lack of maintenance, use of incorrect oil or lubricants, contamination of the oil, or which has served its normal life. This warranty does not apply to any expendable items such as blades, belts, clutch linings, filter elements, flails, flap kits, skids, soil engaging parts, shields, guards, wear pads, pneumatic tyres or tracks.

Temporary repairs and consequential loss - i.e. oil, downtime and associated parts are specifically excluded from the warranty.

Warranty on hoses is limited to 12 months and does not include hoses which have suffered external damage. Only complete hoses may be returned under warranty, any which have been cut or repaired will be rejected. Machines must be repaired immediately a problem arises. Continued use of the machine after a problem has occurred can result in further component failures, for which Spearhead Machinery cannot be held liable, and may have safety implications.

If in exceptional circumstances a non-Spearhead Machinery part is used to affect a repair, warranty reimbursement will be at no more than Spearhead Machinery's standard dealer cost for the genuine part.

Except as provided herein, no employee, agent, dealer or other person is authorised to give any warranties of any nature on behalf of Spearhead Machinery.

For machine warranty periods in excess of 12 months the following additional exclusions shall apply:

- Hoses, exposed pipes and hydraulic tank breathers.
- Filters.
- Rubber mountings.

- External electric wiring.
- Bearings and seals

All service work, particularly filter changes, must be carried out in accordance with the manufacturer's service schedule. Failure to comply will invalidate the warranty. In the event of a claim, proof of the service work being carried out may be required.

Repeat or additional repairs resulting from incorrect diagnosis or poor quality previous repair work are excluded from warranty.

NB Warranty cover will be invalid if any non-genuine parts have been fitted or used. Use of non-genuine parts may seriously affect the machine's performance and safety. Spearhead Machinery cannot be held responsible for any failures or safety implications that arise due to the use of non-genuine parts.

10.1.3 Remedies and procedures

The warranty is not effective unless the Selling Dealer registers the machine, via the Spearhead Machinery web site and confirms the registration to the purchaser by completing the confirmation form in the operator's manual.

Any fault must be reported to an authorised Spearhead Machinery dealer as soon as it occurs. Continued use of a machine, after a fault has occurred, can result in further component failure for which Spearhead Machinery cannot be held liable.

Repairs should be undertaken within two days of the failure. Claims submitted for repairs undertaken more than 2 weeks after a failure has occurred, or 2 days after the parts were supplied will be rejected, unless the delay has been authorised by Spearhead Machinery. Please note that failure by the customer to release the machine for repair will not be accepted as a reason for delay in repair or submitting warranty claims.

All claims must be submitted, by an authorised Spearhead Machinery Service Dealer, within 30 days of the date of repair.

Following examination of the claim and parts, Spearhead Machinery will pay, at their discretion, for any valid claim the invoiced cost of any parts supplied by Spearhead Machinery and appropriate labour and mileage allowances if applicable.

The submission of a claim is not a guarantee of payment.

Any decision reached by Spearhead Machinery is final.

10.1.4 Limitation of liability

Spearhead Machinery disclaims any express (except as set forth herein) and implied warranties with respect to the goods including, but not limited to, merchantability and fitness for a particular purpose.

Spearhead Machinery makes no warranty as to the design, capability, capacity or suitability for use of the goods.

Except as provided herein, Spearhead Machinery shall have no liability or responsibility to the purchaser or any other person or entity with respect to any liability, loss, or damage caused or alleged to be caused directly or indirectly by the goods including, but not limited to, any indirect, special, consequential, or incidental damages resulting from the use or operation of the goods or any breach of this warranty. Notwithstanding the above limitations and warranties, the manufacturer's liability hereunder for damages incurred by the purchaser or others shall not exceed the price of the goods.

No action arising out of any claimed breach of this warranty or transactions under this warranty may be brought more than one (1) year after the cause of the action has occurred.

10.1.5 Miscellaneous

Spearhead Machinery may waive compliance with any of the terms of this limited warranty, but no waiver of any terms shall be deemed to be a waiver of any other term.

If any provision of this limited warranty shall violate any applicable law and is held to be unenforceable, then the invalidity of such provision shall not invalidate any other provisions herein.

Applicable law may provide rights and benefits to the purchaser in addition to those provided herein.

10.2 How to make a claim

In the event of a warranty claim being made, the process of making a claim will be carried out entirely by your selling agent. This is an arrangement that exists between Spearhead Machinery and its agents. All claims will be made via the Spearhead Machinery web site.

Qualifying warranty claims can only be made providing the machine has been previously registered with Spearhead Machinery by the selling dealer before delivery and installation.

The correct part numbers must be quoted when ordering spares, see section 10.3 below.

10.3 How to obtain the correct spare part numbers

For correct part numbers; refer to Spearhead on-line parts books.

These are available at dealerinside.spearheadmachinery.com/dealerinside/.

You will need to enter the machine serial number.

Spearhead Machinery Limited

Green View, Salford Priors, Evesham, Worcestershire, WR11 8SW, England

+44 (0)1789 491860 📞 +44 (0)1789 778683 ✉ enquiries@spearheadmachinery.com 🌐 www.spearheadmachinery.com

Registered office: Station Road, Salford Priors, Nr Evesham, Worcestershire, WR11 8SW, England. Registered in England No. 2312982. VAT No. GB 133 8747 53.